



EHV DISTRIBUTION CHARGING METHODOLOGY (EDCM)

FORWARD COST PRICING MODEL USER GUIDE

6TH NOVEMBER 2023

Prepared by:

**Cambridge Economic Policy Associates Ltd; and
TNEI Services Ltd**



CONTENTS

Glossary	4
1. Introduction.....	7
1.1. Background and purpose to this document	7
1.2. Important notice	7
1.3. Change control.....	9
1.4. Structure of the user guide	11
2. Background to the charging models.....	12
2.1. Background to the DCUSA charging methodologies	12
2.2. Model interactions.....	14
2.3. EDCM approach	15
2.4. EDCM outputs	20
3. Model structure	21
4. Operating instructions	24
5. Information sheets.....	27
6. Inputs	28
7. Calculations	33
7.1. Input pre-processing.....	33
7.2. Charge pre-processing	39
7.3. Charge calculations	44
7.4. Discounts and revenue calculations	56
8. Outputs	61
8.1. EHV tariffs and EHV tariffs transposed	61
8.2. LDNO tariffs and LDNO tariffs transposed.....	61
8.3. Revenue summary, revenue summary transposed, and other model outputs	62
ANNEX A Assumptions log	63

Disclaimer

This report was prepared by Cambridge Economic Policy Associates (CEPA) Ltd for the exclusive use of DCUSA Ltd (the client). It is the result of work undertaken by CEPA Ltd and TNEI Services Ltd (TNEI).

Information furnished by others, upon which all or portions of this report are based, is believed to be reliable but has not been independently verified, unless expressly indicated. Public information, industry, and statistical data are from sources we deem to be reliable; however, we make no representation as to the accuracy or completeness of such information, unless expressly indicated. The findings enclosed in this report may contain predictions based on current data and historical trends. Any such predictions are subject to inherent risks and uncertainties.

The opinions expressed in this report are valid only for the purpose stated herein and as of the date of this report. No obligation is assumed to revise this report to reflect changes, events or conditions, which occur subsequent to the date hereof.

CEPA Ltd and TNEI Services Ltd do not accept or assume any responsibility in respect of the Report to any readers of the Report (Third Parties), other than the client. To the fullest extent permitted by law, CEPA Ltd and TNEI Services Ltd will accept no liability in respect of the Report to any Third Parties. Should any Third Parties choose to rely on the Report, then they do so at their own risk.

CEPA Ltd and TNEI Services Ltd reserve all rights in the Report.

GLOSSARY

Term	Meaning
Allowed revenue	The DNO Party's Allowed Distribution Network Revenue
All-the-way tariff	A tariff applicable to an end user of a DNO Party's network
Annual Review Pack (ARP)	A model completed by each DNO Party that calculates forecast CDCM use of system tariffs for the next five years
Authority	The Gas and Electricity Markets Authority
Common Distribution Charging Methodology (CDCM)	The methodology used for calculating charges to Designated Properties as required by standard licence condition 13A of the Electricity Distribution Licence
CDCM model	The model used in the calculation of CDCM use of system charges
Distribution and Connection Use of System Agreement (DCUSA)	A multi-party contract between licensed electricity distributors, suppliers and generators in Great Britain concerned with the use of the electricity distribution system
DCUSA text	The text of the DCUSA
DCUSA Ltd	The company established, owned, and funded by parties to the DCUSA. The main activity of DCUSA Ltd is to administer the governance of the DCUSA
DCUSA Change Proposal (DCP)	A proposal to change the DCUSA text
Customer contribution	Capital charges payable by customers under the DNO Party's connection charging policy
Distribution losses	Units lost while being transported through the Distribution System
Distribution services area (DSA)	The specified area within which a DNO Party must provide specified distribution services
Distribution system	The system consisting (wholly or mainly) of electric lines owned or operated by a distributor
Distribution network operator (DNO)	A company licensed to distribute electricity in Great Britain by the Authority
DNO party	An electricity distributor who operates one of the 14 DSAs and in whose Electricity Distribution Licence the requirements of Section B of the standard conditions of that licence have effect
DRM	Distribution Reinforcement Model
DSM	Demand side management
EHV	Nominal voltages of at least 22kV and less than 132kV
EHV Distribution Charging Methodology (EDCM)	The methodology used for calculating charges to Designated EHV Properties as required by standard licence condition 13B of the Electricity Distribution Licence
EDCM model	The model used in the calculation of EDCM use of system charges

Term	Meaning
Embedded network	An electricity distribution system operated by an LDNO and embedded within the DNO Party's network
End user	A user that is not a LDNO
Extended Method M	The name for a model previously used to calculate LDNO discounts for application in the EDCM
Forecast Business Plan Questionnaire (FBPQ)	The questionnaire that the DNO Party is required to submit in line with Regulatory Instructions and Guidance issued by the Authority
Forward cost pricing (FCP) methodology	A methodology used in the EDCM to set locational charges based on annual incremental charges for EDCM connectees. A fundamental principle of the FCP model is that the revenue recovery generated from its incremental charges is equal to the expected cost of reinforcement.
GWh	A gigawatt hour of electricity
HV	Nominal voltages of at least 1kV and less than 22kV
IDNO Party	A Party that holds a Distribution Licence in which Section B of the standard distribution licence conditions does not have effect
Licensed distribution network operator (LDNO)	An IDNO Party or DNO Party operating an electricity distribution system outside of its DSA
LDNO boundary	The point at which electric lines or electrical plant that form part of the DNO Party's network are connected to an embedded network that is not owned or operated by the DNO party
LDNO discount	Percentage discounts calculated in the PCDM applied to a DNO Party's all-the-way tariffs
Long-run incremental cost (LRIC) methodology	A methodology used in the EDCM to set locational charges based on nodal incremental costs. These costs represent the brought forward (or deferred) reinforcement costs caused by the addition of an increment of demand or generation at each network node
LV	Nominal voltages of less than 1kV
LV Mains	LV distributing mains where: <ul style="list-style-type: none"> a) the upper boundary is at the secondary side (LV) of a distributor transformer; and b) the lower boundary is the point of connection associated with the LV service
LV Services	The service line from the LV main to the DNO's protection device situated upon the customer's premises, including the joint and associated components connecting the service line to the distributing main
Method M	The name for a model previously used to calculate LDNO discounts for application in the CDCM
Modern equivalent asset value (MEAV)	An estimate of replacement cost

Term	Meaning
Network	The DNO Party's Distribution System within the DNO Party's Distribution Services Area
Network level	A circuit or transformation level between supplies at LV and the transmission network
Network use factors	Scalars which specify the relative value of network assets used by different EDCM customers, calculated within a power flow model.
Nominated Calculation Agent	The provider of specified input values under the DCUSA text
PCDM	The Price Control Disaggregation Model used to calculate LDNO discounts for application in the EDCM and CDCM
Regulatory reporting pack (RRP)	A dataset produced each year by each DNO Party for the Authority
Standing charge factors	A set of numbers (in percentage terms) specified in DCUSA Schedule 16 paragraph 74 which determine the proportion of unit costs allocated to capacity or fixed charges rather than unit rates
Unit	A kilowatt hour of electricity
Use of system charges	Demand Use of System Charges and Generation Use of System Charges
User	Customers (whether demand customers or generators) and (where relevant) LDNOs

1. INTRODUCTION

This section explains the background to this model user guide; presents a change control log; and sets out the structure of the document.

1.1. Background and purpose to this document

CEPA and TNEI have been appointed as service providers to DCUSA Ltd. to re-develop and maintain the charging models used to set electricity distribution use of system tariffs, in line with the Distribution and Connection Use of System Agreement (DCUSA). This encompasses the following methodologies and corresponding models:

- Common Distribution Charging Methodology (CDCM) model.
- Two EHV Distribution Charging Methodologies (EDCM) models.
- Price Control Disaggregation Model (PCDM).
- Annual Review Pack (ARP) model.

This document provides an accompanying user guide to support the use of the EDCM-FCP v11 release of the 2025/26 model, as provided by CEPA/TNEI to DCUSA Ltd. on 6th November 2023, and based on the “Attachment A_2025-26 Charging Methodologies Pre-Release” version of the DCUSA text, which was issued to CEPA/TNEI on 9th October 2023.

The purpose of the document is to provide additional information to users with regards to the EDCM-FCP model. This includes operating instructions, interpretations of the DCUSA text, and explanations of the implementation of the DCUSA text in the model. This document also provides some background on concepts used in the model to aid in the understanding of the charging methodologies. However, the scope of this guide is limited to the implementation of the DCUSA methodologies in the model. Therefore, it does not, for example, include any guidance on any assumptions that should be used when developing input data for the EDCM-FCP model.

1.2. Important notice

This user guide and the model referenced above have been developed in line with:

- Schedule 17 of the “Attachment A_2025-26 Charging Methodologies Pre-Release” version of the DCUSA text;
- the following (if any) DCUSA change proposals (DCPs), where not yet reflected in the abovementioned DCUSA text specification: none; and
- any additional assumptions specified in ANNEX A to this user guide.

The content of this user guide should in no way be interpreted to take precedent over the DCUSA text. However, in preparing this user guide and the model referenced above, it has

been assumed, with approval from DCUSA Ltd, that any assumptions set out in Annex A take precedence over the abovementioned DCPs and DCUSA legal text.

Where the model has been developed in line with DCPs, it is assumed that these take precedence over the DCUSA text. Revisions made to this document over time are summarised in the change control table in the next section.

This document is applicable only to the version of the model and DCUSA text and DCPs referenced herein and should not be used as a guide to any other models or versions of the DCUSA text.

1.3. Change control

This section contains the change control for this document. This document corresponds to the most recent publication referred to in the table below.

Table 1.1: Change control

Document version	Date delivered to DCUSA Ltd.	Corresponding version of DCUSA text	Corresponding charging models	Updates from previous version
1.0	30/05/2018	1 April 2019 pre-release (received 05/03/2018)	EDCM-FCP_v1_20180529.xlsx (provided 30/05/2018)	Original version
2.0	20/07/2018	DCUSA v10.3 (released 28/06/2018)	EDCM-FCP_v2_20180720.xlsx (provided 20/07/2018)	References to DCUSA text updated to comply with version 10.3 (released 28/06/2018)
3.0	12/09/2018	DCUSA v10.3 (released 28/06/2018)	EDCM-FCP_v3_20180912.xlsx (provided 12/09/2018)	Updated references to model
3.0	16/10/2018	01 April 2020 DCUSA Charging Methodologies Pre-Release (released 09/10/2018)	EDCM-FCP_v3_20181016.xlsx (provided 16/10/2018)	Updated references to legal text version
4.0	08/11/2019	01 April 2021 DCUSA Charging Methodologies Pre-Release (issued to CEPA/TNEI 10/10/2019)	EDCM-FCP_v6_20191108.xlsx (provided 08/11/2019)	Updated references to legal text version and edits throughout to reflect DCP268, DCP332, DCP333 and DCP356.
5.0	30/01/2020	01 April 2021 Charging Methodologies Pre-Release – December 2019 (Schedules 15-16-17-18-20-29) (DCPs 268-332-333-341-342-356) (issued to CEPA/TNEI 19/12/2019)	EDCM-FCP_v7_20200130.xlsx (provided 30/01/2020)	Updated references to legal text version and edits throughout to reflect DCP341 and DCP342

Document version	Date delivered to DCUSA Ltd.	Corresponding version of DCUSA text	Corresponding charging models	Updates from previous version
8.0	06/11/2020	01 April 2022 Charging Methodologies Pre-Release – October 2020 (Schedules 16, 17, 18, 20 and 29) DCP 361 (issued to CEPA/TNEI 15/10/2020)	EDCM-FCP_v8_20201106.xlsx (provided 06/11/2020)	Updated references to legal text version and edits throughout to reflect DCP361.
9.0	23/02/2021	01 April 2022 Charging Methodologies Pre-Release – October 2020 (Schedules 16, 17, 18, 20 and 29) DCP 361 (issued to CEPA/TNEI 15/10/2020); and Attachment A_DCP 379 Draft Legal Text” (issued to CEPA/TNEI on 16/02/2021)	EDCM-FCP_v10_20210223.xlsx (provided 23/02/2021)	Updated to reflect DCP 379.
9.0	22/11/2021	Attachment A_Charging Methodologies Pre-Release_01042023 (issued to CEPA/TNEI on 15/11/2021)	EDCM-FCP_v10_20211122.xlsx (provided 22/11/2021)	Release for charge setting. Cover sheet, version control and annotation changes only.
9.0	27/10/2022	Attachment A_2024-25 Charging Methodologies Pre-Release (issued to CEPA/TNEI on 6/10/2022)	EDCM-FCP_v10_20221027.xlsx (provided 27/10/2022)	Release for charge setting. Cover sheet, version control and annotation changes only.
9.0	06/11/2023	Attachment A_2025-26 Charging Methodologies Pre-Release (issued to CEPA/TNEI on 09/10/2023)	EDCM-FCP_v11_20231106.xlsx (provided 06/11/2023)	Release for charge setting. Cover sheet, version control, and some tariff names changed for DCP 414.

1.4. Structure of the user guide

The remainder of this document is set out as follows:

- Section 2 explains some of the **background to the EDCM model** - including an explanation of the DCUSA charging methodologies, and how the EDCM model relates to the other models used to produce distribution use of system charges;
- Section 3 summarises the **structure of the EDCM model**;
- Section 4 issues instructions on **how to operate the EDCM model**;
- Sections 5-8 each correspond to part of the EDCM model:
 - Section 5 explains the purpose of the **information sheets**;
 - Section 6 provides a commentary on the **model input sheets**;
 - Section 7 walks through each of the **calculation sheets** - explaining their purpose, how they correspond to the DCUSA text, what further assumptions are made in the way the model implements the text, and providing further explanation on the economic and/or engineering rationale where necessary;
 - Section 8 explains the contents of the **output sheets**;
- Annex A contains a **log of assumptions** used to clarify or amend the DCUSA legal text.

2. BACKGROUND TO THE CHARGING MODELS

This section sets out some background on the DCUSA charging methodologies before providing a high-level overview of the EDCM-FCP model, the subject of this user guide.

This section explains some of the background to the EDCM model for users who are not familiar with the broader set of DCUSA charging models. It introduces the suite of charging models (2.1); describes how they interact with each other (2.2); summarises the overall rationale of the EDCM approach (2.3); and lists the outputs that it produces (2.4).

2.1. Background to the DCUSA charging methodologies

A key part of the DCUSA is the common framework it sets out for calculating charges paid by users of DNO systems. The objectives of the charging methodologies, set out in the Schedules of the DCUSA text, include the promotion of competition in the generation and supply of electricity, and the cost-reflectivity of tariffs.

The DCUSA charging methodologies cover use of the system but not connection, which is governed by a separate Common Connection Charging Methodology (Schedule 22 of the DCUSA).

Charging methodologies are split by voltage level and are implemented by DNO Parties through a set of standardised charging models published by DCUSA Ltd:

- **Common Distribution Charging Methodology (CDCM)**, set out in DCUSA Schedule 16, covers the calculation of tariffs for users connected to high voltage (1-22kV) and low voltage (sub-1kV) networks.
- **Extra high voltage Charging Methodology (EDCM)** covering the calculation of site-specific charges for users connected to the distribution network above 22kV or within the boundary of an HV primary substation. The EDCM is further separated into two methodologies and corresponding models:
 - the forward cost pricing (FCP) method, set out in DCUSA Schedule 17; and
 - the long-run incremental cost (LRIC) method, set out in DCUSA Schedule 18.
- **Price Control Disaggregation Model (PCDM)**, the specification of which is set out in DCUSA Schedule 29, calculates discounts applied to tariffs for LDNOs in the CDCM and EDCM models.

In other words, customers are split between the EDCM and CDCM based on the voltage level of their connection, as summarised in the table, and in Figure 2.1, which represents the boundary on a single line diagram.

Table 2.1: Charging methodologies used based on voltage of customer connection

Voltage of customer connection	132kV	132kV/EHV	EHV	EHV/ HV	HV	HV/LV	LV
Charging methodology used	EDCM				CDCM		

Figure 2.1: Single line diagram showing charging methodology boundaries

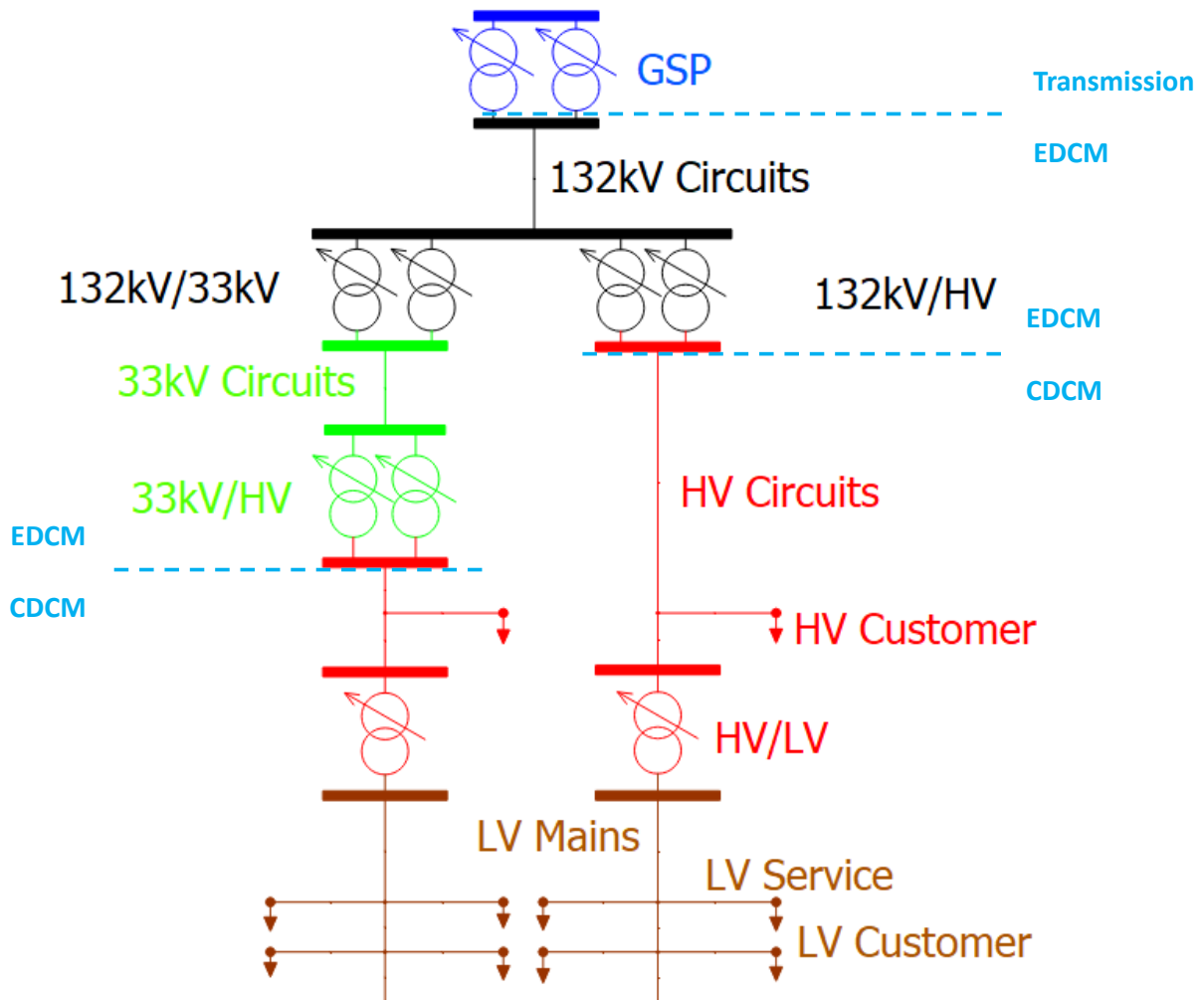

Customers subject to charging through the EDCM model are likely to have larger import or export capacities than those connected to LV or HV voltage levels. Each EDCM customer has more potential to drive network reinforcement requirements through their use of the distribution system, and they are typically more capable of being able to understand and react to charging incentives. The EDCM model, therefore, calculates bespoke tariffs for each individual customer - whereas the CDCM model calculates a common tariff for each group of customers in the same “customer category”.

In addition to the four core charging models which correspond directly to a charging methodology, DNOs also produce an **Annual Review Pack (ARP)** model which forecasts CDCM

tariffs over a five-year period. The requirements of the ARP are set out in DCUSA Schedule 21. The ARP model is an extension of the CDCM model and contains all of its sheets.

2.2. Model interactions

The four core charging models are used by DNO Parties to produce distribution tariffs each year, with each using either the FCP or the LRIC version of the EDCM. Tariffs produced by the models are calibrated to allow DNOs to recover their allowed revenue for the charging year, as set by Ofgem. In order to achieve this, there are interactions between the models, as shown in Figure 2-2. The PCDM requires data on network assets from the EDCM and CDCM to calculate discounts applied to CDCM LDNO tariffs.¹ In turn, the EDCM and CDCM require the LDNO discounts from the PCDM to calculate LDNO tariffs. The EDCM and CDCM interact by exchanging information on network characteristics and revenues recovered through tariffs.

Figure 2.2: Interactions between models

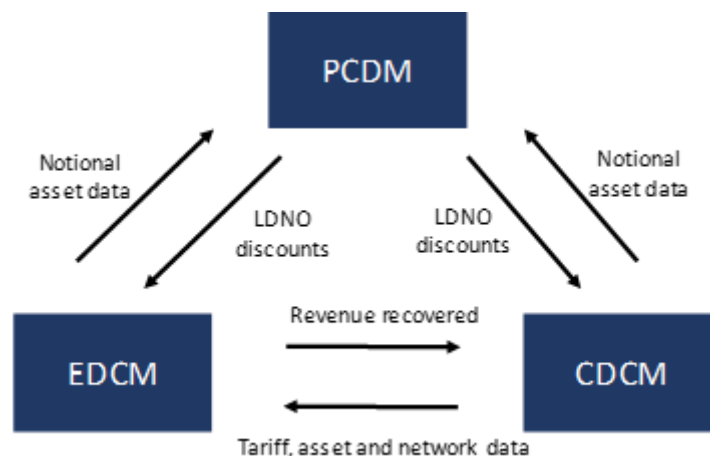

The amount of revenue expected to be recovered through EDCM tariffs is an important input into the CDCM model. Both EDCM and CDCM models calculate tariffs which are intended to be cost-reflective, but then scale those tariffs upwards or downwards to allow DNOs to recover the amount of revenue allowed to them (as determined through their price control settlements).

The DCUSA text does not stipulate how DNOs have to solve these interactions. Some DNOs copy-paste inputs and outputs between models a fixed number of times (e.g. three). Others use macros to run interactions until the models resolve to a fixed number of decimal places.

The difference between allowed revenue and the revenue that would be recovered through cost-reflective tariffs (CDCM plus EDCM tariffs) is called 'residual revenue'. Some residual revenue is recovered from EDCM tariffs (this is included as part of the EDCM revenue target). Recovery of the full revenue allowance is then achieved by scaling tariffs in the CDCM for

¹ The information from the EDCM and CDCM is used to calculate the EHV reduction factor, which is only applied in the CDCM discounts.

customers connected to the HV and LV networks. Figure 2.3 illustrates how residual revenue is recovered through the interaction of the EDCM and CDCM models.

Figure 2.3: Recovery of residual revenue

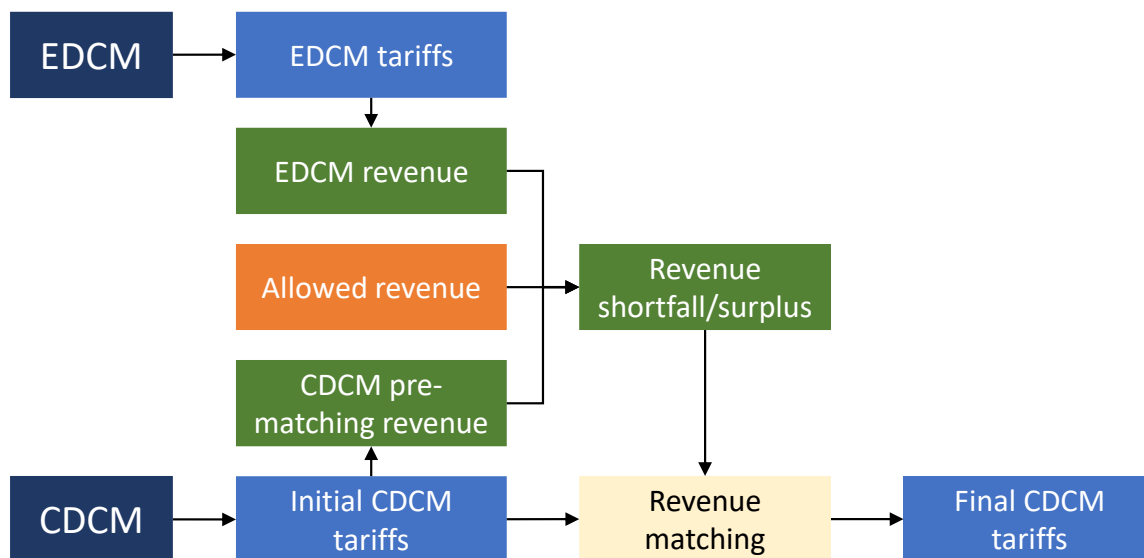

(Note: revenue scaling in the EDCM has been excluded from the diagram for simplicity)

2.3. EDCM approach

The Extra High Voltage Distribution Charging Methodology (EDCM) is the approach used to derive tariffs for customers connected to the Extra High Voltage (EHV) distribution network – that is, customer types not covered by the tariffs in the Common Distribution Charging Methodology (CDCM). The calculations are implemented in the EDCM model.

The EDCM allocates revenues to individual customers based on cost-reflective power flow modelling. Specific tariffs are calculated for each relevant import and export customer. The tariffs include a p/kVA/day capacity charge, a p/kVA/day exceeded capacity charge, a p/kWh super-red unit rate, and a p/day fixed charge.

There are two different variants of the EDCM methodology:

- Six of the DNO licence areas use the Forward Cost Pricing (FCP) variant, as described in Schedule 17 of the DCUSA
- Eight of the DNO licence areas use the Long Run Incremental Cost (LRIC) variant, as described in Schedule 18 of the DCUSA

FCP and LRIC are two different ways of calculating the cost-reflective element of the charge. The rest of the methodology is the same for both EDCM variants. This model guide describes the FCP variant of the methodology and model.

Some of the concepts used within the calculation of EDCM charges are described in more detail below.

2.3.1. Forward Cost Pricing

The FCP methodology separates the network into a number of ‘Network Groups’. The FCP demand price is calculated by assessing network reinforcement cost to support a maximum of 15% demand increment for each network group over the next 10 years. The potential reinforcement cost is calculated and averaged at each voltage level within the same network group such that the total revenue recovered equals to the forecasted reinforcement cost plus a certain level of investment return. The FCP charges within a network group are the same for all the customers connected to that group.

The outputs of the FCP power flow method are a £/kVA/year “Charge 1” for every group defined in the DNO’s network. A group is either;

- 132 kV and similar circuits (a “level 1” group)
- 132 kV/33 kV and similar substations with 33 kV and similar circuits (a “level 2” group)
- 132 kV/11 kV or 33kV /HV primary substations (a “level 3” group).

Example of these groups are shown in Figure 2.4, which is adapted from Figure 2.1

Figure 2.4: EHV single line diagram showing network groups

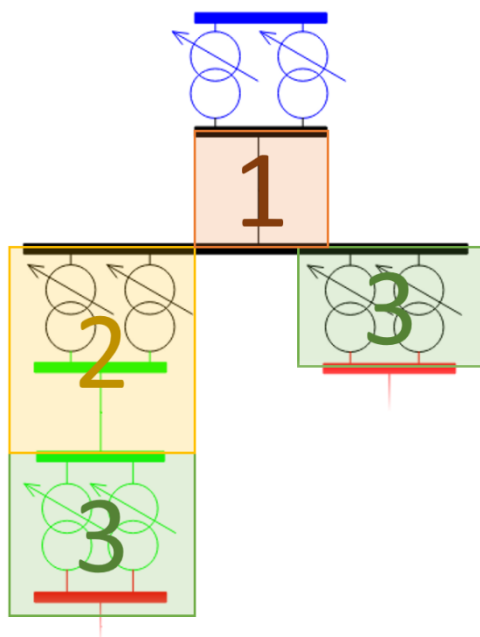

Each group may also have “parent group” associated with it. The parent group of a parent group is referred to as a “grandparent group”. For example, the parent group of the level 3 group of 33 kV/HV substations would be the level 2 group above it, and its grandparent group would be the level 1 group above that.

The AC power flow analysis is completed outside of the model described in this user guide, and the results are entered as input data.

2.3.2. Long Run Incremental Cost

The LRIC methodology calculates nodal incremental costs, which represent the deferred reinforcement costs caused by the addition of demand or generation at each network node. AC power flow analysis is used to take account of how a change in connectee behaviour affects the network. This enables calculations of the time needed before reinforcement is required at different points on the network and subsequently the net present value (NPV) of the future costs of reinforcement.

The outputs of the LRIC power flow method are a £/kVA/year local “Charge 1” and a remote “Charge 1” for each location in the model, where the local charge refers to the local network and the remote charge refers to higher voltage levels. In addition, each LRIC location may have a “linked location”, in order to define clusters of up to eleven locations which are processed together.

The AC power flow analysis is completed outside of the model described in this user guide, and the results are entered as input data.

2.3.3. Network Use Factors

Network use factors (NUF) are a measure of the relative value of assets used by customers at different locations within the EHV network. Every customer may have a NUF defined for each of the five network levels considered within the EDCM. These are used in order to determine unique network asset rates for every customer associated with their access to (capacity) and usage of (demand) the network.

Network use factors are used in the calculation of “asset-based” elements of the import capacity charges. This includes the network rates and direct operating costs element of this charge, as well as the asset-based residual revenue element.

The calculation of NUFs is described in more detail in DCUSA Schedule 17 Section 29 and Section 30. NUFs are calculated by the DNOs outside of the EDCM model and are entered into this model as an input.

2.3.4. Super-red hours

Super-red hours are the hours in a DNO's super-red time band representing the times of peak load on the network. Generally, the super-red hours occur during weekdays and very seasonally, reflecting differences in energy consumption at different times of the year. The exact times differ across the 14 DNO networks.

The average kW/kVA and average kVAr/kVA figures are forecast for the Charging Year based on historic data. Active (kW) and reactive (kVAr) power consumptions are averaged over the super-red time band and then divided by the Maximum Import Capacity (averaged over the same financial year). If the DNO Party considers that the reactive consumption data relates

to export rather than import, then the Maximum Import Capacity in the denominator should be replaced by the Maximum Export Capacity of the same Connectee.

Within the calculation of charges in the EDCM-FCP model, the average kVAr divided by kVA is adjusted such that the combined active and reactive power flows cannot exceed the Maximum Import Capacity.

2.3.5. Customer categories

Every EDCM customer is assigned a customer category. Customer categories are defined based on a user's point of common coupling. They take the form of a four-digit number, each digit of which can take (in most cases) a value of 0 or 1. This can be interpreted as a binary indicator as to whether that customer category uses one of the EHV voltage levels, as shown in the table below, which is adapted from Table 15.9 of DCUSA Schedule 17.

A "1" indicates that customers within that category do use that network level, and a "0" indicates that they don't.

Table 2.2: Network levels used by each customer category

Category	Use of voltage level				
	132kV	132kV/EHV	EHV	EHV/HV	132kV/HV
0000	0	0	0		0
1000	1	0	0		0
1100	1	1	0		0
0100	0	1	0		0
1110	1	1	1		0
0110	0	1	1		0
0010	0	0	1		0
0001	0	0	0	0	1
0002	0	0	0	1	0
1001	1	0	0		1
0011	0	0	1		1
0111	0	1	1		1
0101	0	1	0		1
1101	1	1	0		1
1111	1	1	1		1

The only exception is in categories 0001 and 0002, where 0001 refers to customers connected to the EHV/HV voltage level and 0002 refers to customers connected to the 132 kV/HV voltage level.

Examples of each category are shown drawn on a single line diagram in Figure 2.5, which is reproduced from Paragraph 15.8 of DCUSA Schedule 17.

Figure 2.5: Single line diagram showing definition of customer categories

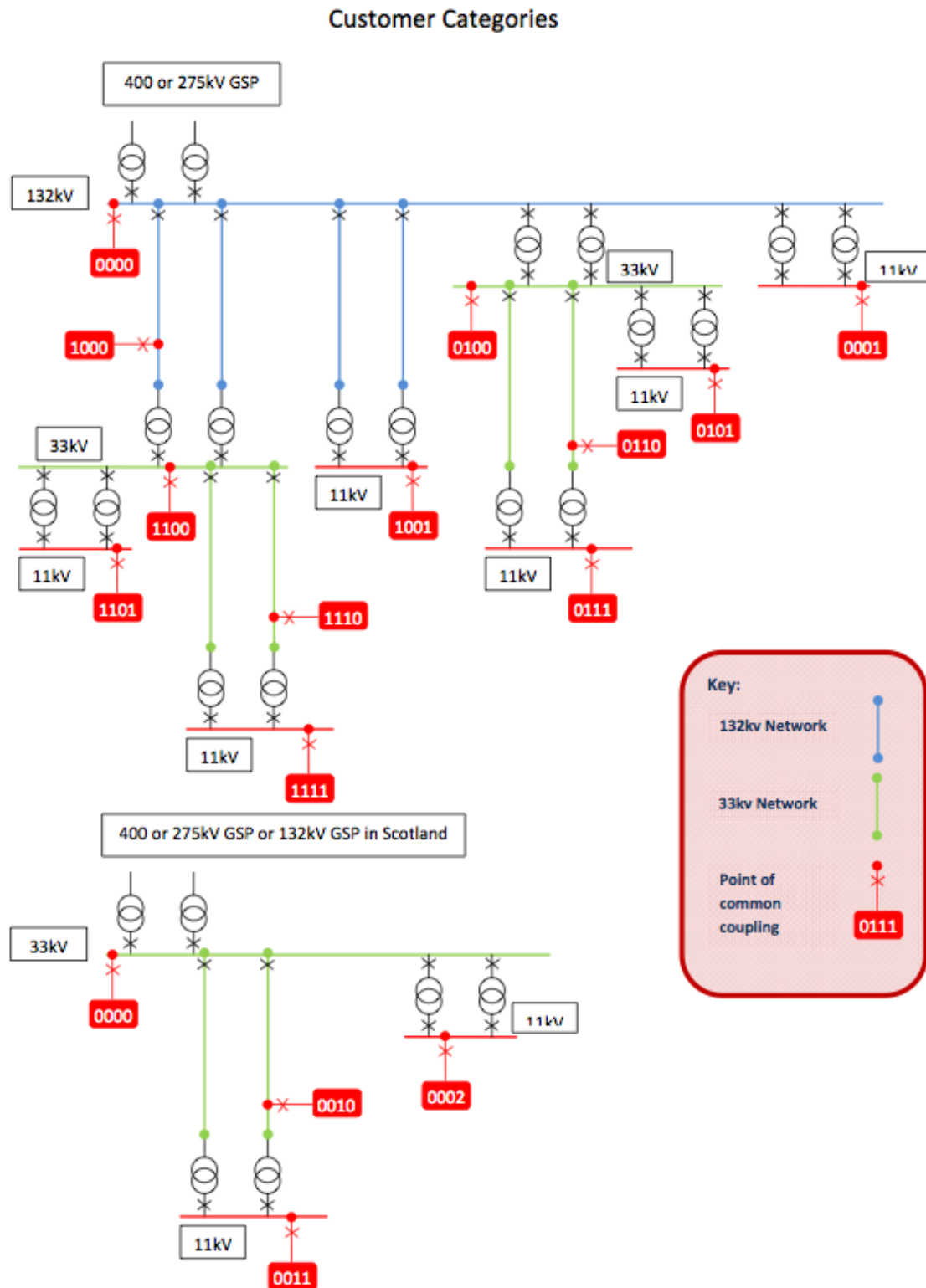

2.4. EDCM outputs

The EDCM model calculates up to eight bespoke charges for each user. This is distinct from the CDCM model, which groups customers into several customer categories and calculates a different tariff for each group.

A tariff consists of up to eight types of charge, though not all customers receive all types of charge:

- Import fixed charge (p/day)
- Import capacity charge (p/kVA/day)
- Exceeded import capacity charge (p/kVA/day)
- Super-red import unit charge (p/kWh)
- Export fixed charge (p/day)
- Export capacity charge (p/kVA/day)
- Exceeded export capacity charge (p/kVA/day)
- Export super-red unit rate (p/kWh)

Customers with zero maximum import capacity will not have any import tariffs and customers with no chargeable export capacity will not have any export tariffs.

In addition, the EDCM model calculates discounted CDCM tariffs for LDNO connected customers whose LDNO boundary is on the EHV network. Discounted CDCM tariffs are calculated for five LDNO boundaries:

- **0000 LDNO:** LDNO boundary at the Grid Supply Point.
- **132kV LDNO:** LDNO boundary on the 132kV circuits.
- **132kV/EHV LDNO:** LDNO boundary within the 132kV/EHV substation.
- **EHV LDNO:** LDNO boundary on the EHV circuits.
- **HVplus LDNO:** LDNO boundary within the EHV/HV substation.

For each boundary and tariff category, the following tariffs may be calculated:

- Up to three unit-rates (p/kWh)
- Fixed charge (p/day)
- Capacity charge (p/kVA/day)
- Exceeded capacity charge (p/kVA/day)
- Reactive power charge (p/kVArh)

3. MODEL STRUCTURE

As shown in Figure 3.1 below, sheets in the EDCM are grouped into four main sections: (i) information sheets; (ii) inputs; (iii) calculations; and (iv) outputs.

Figure 3.1: EDCM model map

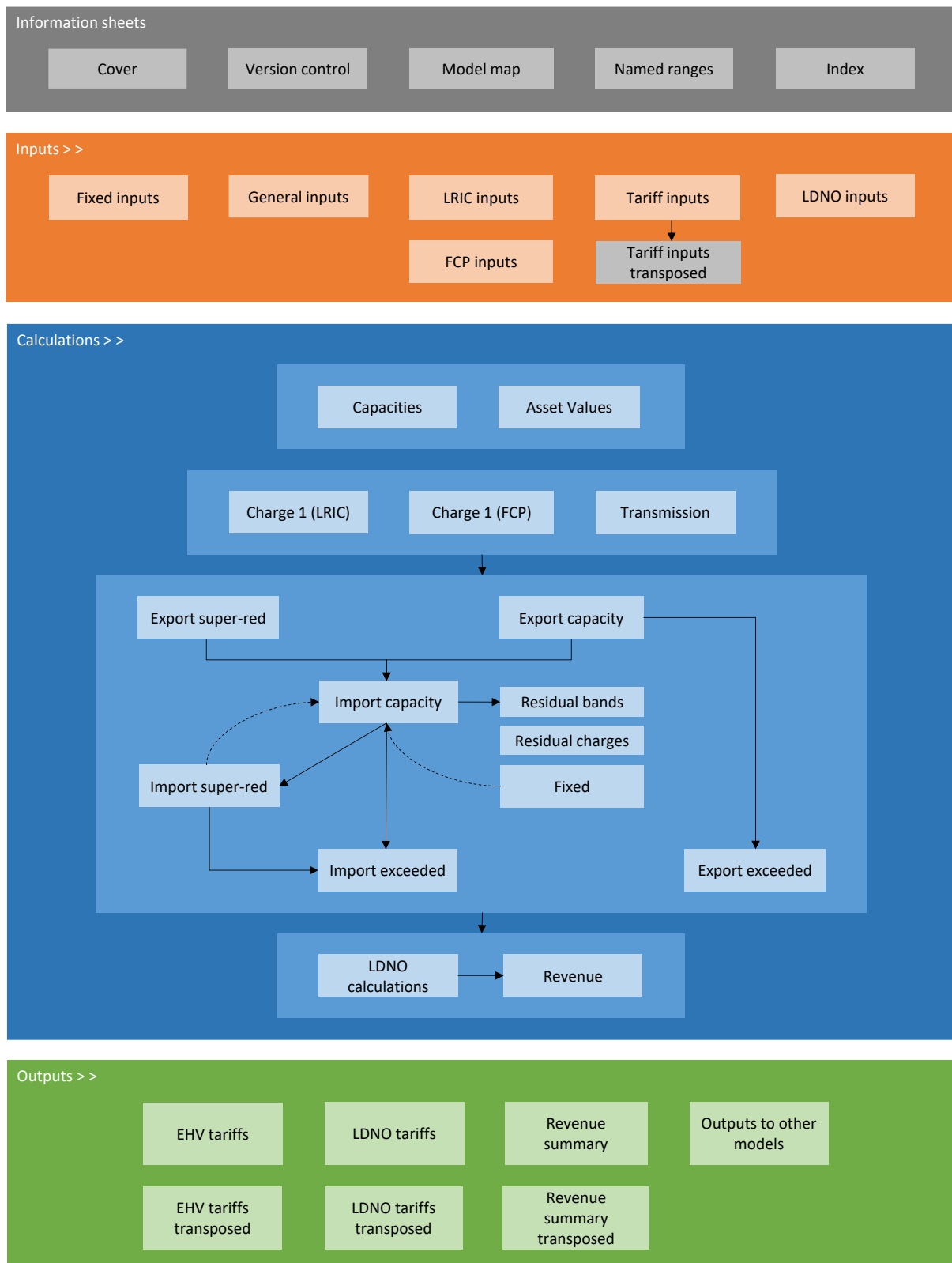

Each box relates to a different worksheet, and the general flow from inputs to outputs is represented by the top-to-bottom flow of the diagram. There is a clear separation between inputs, calculation, outputs and general information sheets; colour coding is used to further distinguish these.

In order to aid consistency, the model contains functionality for both the FCP and LRIC methodologies. Before publication, the desired methodology is selected on the “Fixed inputs” sheet. The FCP inputs sheet and Charge 1 (FCP) sheet is used in the FCP model, whereas the LRIC inputs sheet and Charge 1 (LRIC) sheet are not used.

The information sheets section contains the cover sheet, version control sheet, a clickable model map similar to that shown above and an index sheet with links to the main sections of each sheet and to each of the model’s input and output tables and the calculation sections.

The inputs are then split into six separate sheets. The ‘Fixed inputs’ sheet contains inputs that should not be altered by users, while the other sheets contain tables for users to input financial, network, load and other inputs.

The calculations section of the models has been split across multiple tabs to ensure a logical flow of calculations through the model. There are four general categories:

1. Pre-processing of inputs, including adjustments and calculations of capacities and calculations of asset values which feed into later calculations.
2. Pre-processing of charges, i.e. the initial steps of the charge calculations which flow into later steps.
3. Charge calculations, the calculation of individual export and import tariff components.
4. Calculation of LDNO tariffs and overall revenues.

The final model outputs are the EHV tariffs and the LDNO tariffs; both of these outputs are replicated across two sheets, with one sheet being the transpose of the other in order to format the outputs in the most practical way for user post-processing. Two additional output sheets are included that (i) summarise the revenues that will be recovered from the different charges, and (ii) presents the outputs for the other models.

Some of the specific flows of information between worksheets are represented explicitly on the model map. This also includes some bi-directional flows of information to and from the import capacity sheet. This is necessary due to the complexity of these calculations. For example, % contribution rates are calculated in the import capacity sheet, and these are also used in the calculation of the fixed charges. However, a later step in the import capacity calculation relies on the calculation of the fixed charges.

In general, most worksheets are structured using a separate column for each customer for whom tariffs are being calculated - on these sheets, *Column L* through *Column WM* allow for tariffs for up to 600 customers to be calculated. In addition, on each of these sheets, *Column J* can be used to investigate the calculations for a specific customer.

On sheets related to the calculation of LDNO discounts, Column J through Column AJ calculate discounted tariffs for each category of CDCM tariff.

On every sheet, the final column is used for referencing back to the legal text.

Within the sheets of the charging models, input, calculation and output sections are labelled following a consistent convention, summarised as follows:

- Separate labels are generated for inputs, calculations (labelled as “Section”) and outputs.
- The first number represents the model number, set out in Table 3.1 below.
- The second and third numbers represent the order of input sheets within the model. The first input sheet will have a value of 01, and so on.

The letter (separated from the numbers with a hyphen) represents the order within a sheet, from top to bottom.

For example, a section with the label of “Input 402-E” would represent the fifth input section, on the second input sheet in the PCDM; a label of “Section 104-B” would represent the second calculation section on the fourth calculation sheet of the CDCM.

Table 3.1: Model numbers

Model	Number
CDCM	1
EDCM (LRIC)	2
EDCM (FCP)	3
PCDM	4
ARP	5

A list with clickable hyperlinks to each labelled section is provided on the “Index” sheet.

4. OPERATING INSTRUCTIONS

The charging models use a consistent set of cell formats to help users operate and understand the model. These are reproduced in Figure 4.1 below.

Figure 4.1: EDCM cell formats and sheet colours

Format	Description
	Cell intentionally blank
Value	Hardcoded input
Value	User input
Value	Model output
Value	Calculation
Value	Value from another worksheet
Value	Value used on another worksheet
Value	Issue identified in a check
Text	Label
Text	Annotation
Text	Column heading
Text	Level 1 heading
Text	Level 2 heading
Text	Level 3 and 4 heading
Sheet tab colour	Information sheet
Sheet tab colour	Input sheet
Sheet tab colour	Calculation sheet
Sheet tab colour	Output sheet

To operate the EDCM model users should ensure that they have filled in all user input cells (shaded yellow) in the following model input sheets:

- General inputs
- FCP inputs
- Tariff inputs
- LDNO inputs

Where users do not have data of a particular type (e.g. where volumes for a certain customer class are zero), users should input zero instead of leaving cells blank. This helps to differentiate between missing inputs and inputs which are intentionally zero. In most cases, values of exactly zero are formatted as “–” in the model.

In addition, each input sheet includes checks for certain criteria at the bottom of the sheet. These checks will create a flag (value of one or higher) when certain criteria have been broken. When flags take a value other than zero, this indicates that inputs have been incorrectly specified. These flags are not intended to capture all types of potential input errors and, consequently, users should also undertake their own input validation procedures.

Where appropriate, inputs include data validation and input messages to help guide users how to input values into the model (an example from the PCDM is shown in Figure 4.2 below).

Figure 4.2: Example of validation and input messages from the PCDM

The screenshot shows a section titled "Nominated Calculation Agent inputs". It contains two input fields: "Input 402-A: LV mains split" and "Input 402-B: HV split". The "LV mains split" field has a value of 25.68% and a validation message: "Validation requires the value to be greater than 0%". The "HV split" field has a value of 65.00% and a validation message: "Input messages provide information on how inputs should be specified." A tooltip for the "LV mains split" field shows "LV mains split Minimum value 0%".

The EDCM models contain a variety of other in-built checks throughout the model, summarised at the end of each sheet. All model checks are summarised on the "Version control" tab, near the bottom of the sheet (an example is shown in Figure 4.3 below). Once all relevant data has been input to the model, users should check the summary of in-built model checks to ensure that no issues have been identified. If there are issues, Row 4 of the version control sheet will be highlighted in red as in Figure 4.4.

Figure 4.3: Summary of in-built model checks

Issues identified by in-built model checks, by sheet

LRIC inputs	0
FCP inputs	2
Tariff inputs	0
Capacities	0
Aseet values	0
Charge 1 (LRIC)	0
Charge 1 (FCP)	0
Transmission	0
Export super-red	0
Export capacity	0
Import capacity	0
Import super-red	0
Fixed	0
Import exceeded	0
Exported exceeded	0
Revenue	0
EHV tariffs	0
Revenue summary	0
Total	2

Two issues identified of FCP inputs sheet

If any checks flag an issue, then Row 4 of the relevant sheet will display with a red background, and the total number of issues will be given. This is illustrated in Figure 4.4.

Figure 4.4: Example of highlighting Row 4 for warning messages

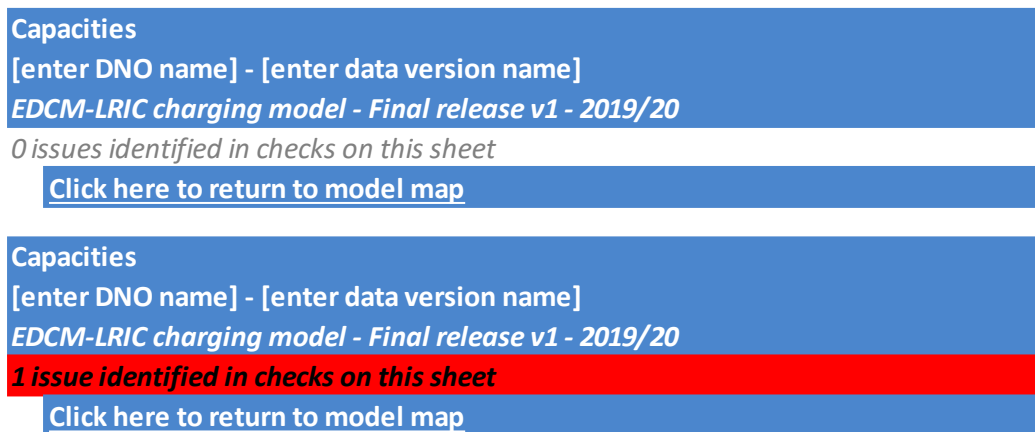

Given the input data specified, the EDCM-FCP model will produce a set of EHV use of system tariffs on the “EHV tariffs” and “EHV tariffs transposed” sheets, and a set of discounted LDNO tariffs on the “LDNO tariffs” and “LDNO tariffs transposed” sheets. Revenues recovered from each tariff are summarised in the “Revenue summary” sheet. To facilitate running the full suite of charging models, outputs to other models are summarised on the “Outputs to other models” sheet.

In addition, on many of the sheets, users can choose to display tariff information related to a specific customer. This is done by selecting the value from the drop-down list in Column J on each of these sheets which corresponds to the tariff to be examined. The data used to populate this drop-down list can be entered by the user in the “Tariff inputs” sheet – for example, users may wish to enter the tariff name, a unique ID number or numbers 1 through 600.

In addition, users can also enter two other identifiers in the Tariff inputs sheet. This could be, for example, the Import LLFC and/or Export LLFC.

By default, the structure of the workbook and all the sheets within it are protected, so that users can only change inputs cells, fixed inputs cells, filters and cell formats. The model can easily be ‘unlocked’ by unprotecting the sheets and unprotecting the workbook through Excel’s “Review” tab. By default, there is no password for this protection.

Figure 4.5: Protecting and unprotecting the workbook

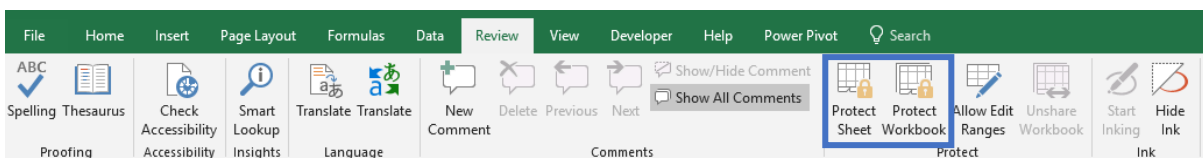

5. INFORMATION SHEETS

The EDCM-FCP model contains five information sheets that provide information and aid with model navigation, but which do not affect the calculations or results of the model. These are:

- **Cover**, which sets out the DNO and charging year to which the model applies, as well as model data version. Cover also summarises the model publication date and version of DCUSA text to which the model corresponds.
- **Version control**, setting out the version of the model published by DCUSA Ltd, and any changes from the previous model version. This sheet also provides a summary of in-built model checks. This sheet also summarises which tariff has been selected in column I using the selected customer functionality, for sheets where this functionality exists.
- **Model map**, providing an interactive schematic of the model.
- **Named ranges**, setting out the name, description and location of all of the named ranges used in the model.
- **Index**, providing a list of and hyperlinks to all major section headings throughout the model, as well as to input and output tables and calculation sections.

No content on these sheets should affect the calculations of the model.

In addition to the information sheets, each tab in the workbook contains a description of the worksheet and annotations to tables and section headings where appropriate. References to the DCUSA text are also provided throughout the model in the right-hand most column (and indicated with a chevron ">" in column I). All references to paragraphs and tables in that column are made with reference to the Schedule and version of the DCUSA text noted in Section 1.3 of this document.

6. INPUTS

The EDCM models contains six input sheets as summarised in the following subsections.

Four of these input sheets are common across both the LRIC and FCP models. One of the input sheets is used for FCP inputs only and the remaining input sheet is related to LRIC inputs only and should not be used within the FCP model.

Fixed inputs

The “Fixed inputs” sheet contains inputs that should not be altered by the user. These inputs are constant across DNOs and are either specified explicitly in the DCUSA text (e.g. in the case of EHV operating expenditure intensity factor), enable model functionality or are identities (e.g. hours per day). Input table 301-A/201-A on the Fixed inputs sheet allows users to choose whether to operate the LRIC model or the FCP model.

General inputs

This sheet contains a range of inputs which are used throughout the model.

The model includes guidance on the form which inputs should take, and will note errors if:

- Any percentages are inputted with values greater than 100%.
- Any cells are completed as text where a number is expected.
- Any cells are completed as numbers where text is expected.

The following input tables are to be completed:

- **Financial information:** £ per year values are to be entered for various categories of expenditure.
- **Calendar and time band information:** For the charging year, the number of days in the year and the number of hours in the super-red time band are to be entered.
- **Generation data:** £ per year generation incentive revenues are entered, as are the total CDCM generation capacities in kVA for 2005-2010 and post 2010.
- **Data from the CDCM model:** Outputs from the CDCM model are entered, from “Output 102-C” in the CDCM model.
- **Override notional asset:** An override notional asset rate in £/kW may be entered for 132kV/HV assets. If this isn’t to be used, then the input cell should be left blank.
- **Network use factor cap and collar.** Network use factor cap and collars are entered as scalars. These vary by voltage level.
- **Revenue pass through costs for fixed cost adders.** These are the total amounts for Supplier of Last Resort adjustment, Eligible Bad Debt adjustment and COVID-19 Bad Debt adjustment, as detailed in the general inputs to the CDCM.

- **LDNO discount percentages:** LDNO discount percentages for EDCM customers are entered as %. These are taken from the PCDM model, “Output 401-B”.

LRIC inputs

This sheet contains inputs to be filled in by users following the LRIC EDCM methodology. These are the inputs that will be produced by the LRIC power flow model.

All of these inputs are different for every LRIC location. The version of the model described in this guide can accommodate up to 1200 unique LRIC locations.

The following input tables are to be completed:

- **Customer info.** The location name/ID and the linked location (if applicable) are to be entered. The model will only permit linked locations to be entered which are also defined as locations. If a linked location is entered which is not defined as a location, the model will identify an issue.
- **Charge 1.** This includes the Local charge 1 and Remote charge 1 values obtained from the LRIC power flow modelling.
- **Maximum demand run power flows.** The active power and reactive power for each location are entered here. Importing flows are entered as a negative value, whereas exporting flows are entered as a positive value.

FCP inputs

The “FCP inputs” sheet contains inputs to be filled in by users following the FCP EDCM methodology. These are the inputs that will be produced by the FCP power flow model.

All of these inputs are different for every FCP group. The version of the model described in this guide can accommodate up to 1200 unique FCP groups.

The following input tables are to be completed:

- **Customer info.** The group name/ID and the parent group are to be entered. The model will only permit parent groups to be entered which are also defined as groups. If a parent group is entered which is not defined as a group, the model will identify an issue.
- **Charge 1.** This includes the Charge 1 value for all locations obtained from the FCP power flow modelling.
- **Maximum demand run power flows.** This table includes the load and generation active and reactive powers respectively. Importing flows are entered as a negative value, whereas exporting flows are entered as a positive value.

Tariff inputs

The “Tariff inputs” sheet contains inputs that are relevant to each customer for which tariffs are being created, such as their import and export capacities and their sole use assets.

All of these inputs are different for every customer. The version of the model described in this guide can accommodate up to 600 unique tariffs.

The following input tables are to be completed:

- **Customer info.** Identifying information, such as the tariff, the FCP group, the customer category and the residual band. Customer category inputs are restricted to the fifteen defined within the DCUSA legal text. These should be entered as numbers, rather than text.

Users can also enter a tariff lookup ID for selecting customers on later sheets, as well as two other pieces of identifying information (such as Import and Export LLFC).

- **Import capacities.** The maximum import capacity, the capacity subject to Demand side management (DSM) and the proportion exposed to indirect cost allocation and fixed adder are to be provided here. The number of days for which not a customer is also entered in this table.

Import capacities of zero should be entered explicitly as “0”. This is different to previous versions of the EDCM-FCP model, where capacities of zero were entered as “VOID”.

Users can also define here the site’s metered import consumption, and whether or not it is a final demand site, for the purpose of calculating residual charges. Users should take care to ensure that the right residual bands are selected in combination with whether the site is a final demand site (e.g. in the case of Non-Final Demand sites, where no residual band should be allocated).

- **Export capacities.** The exempt and non-exempt export capacity of a customer, the capacity eligible for GSP generation credits and charge 1 credits are all entered in this table.

Export capacities of zero should be entered explicitly as “0”. This is different to previous versions of the EDCM-FCP model, where capacities of zero were entered as “VOID”.

- **Super-red data.** This table includes the super-red units exported, the hours spent in the super-red time band for which not a customer and the super-red kW and kVAR import divided by kVA capacity as separate inputs. The model will give a warning if kVar/kVA values greater than 1 are entered, although it will still calculate charges².

² These values may be greater than unity if the relevant customer is expected to exceed their capacity during the super-red period.

- **Sole-use assets.** The MEAV of sole use assets for each customer and the percentage of these assets where the customer is entitled to reduction for capitalised operation and maintenance (O&M) are to be entered here.
- **Network use factors.** The network use factors for each customer across the network levels are to be provided in this table.
- **Previous year charges.** The import and export charge levied on each customer in the previous charging year is included here.

Tariff inputs transposed

The 'Tariff inputs transposed' sheet transposes the 'Tariff inputs' sheet so the individual tariffs are presented down the rows of the sheet rather than across the columns. This sheet has been provided to assist users in carrying out analysis and auditing processes and the values are not used in calculations in the model. This sheet is coloured in Grey to denote that, in practice, it is really an information sheet, as no inputs, calculations or outputs are contained within it.

Auto-filters have been set up on the inputs table so that users can easily validate their inputs.

LDNO inputs

This sheet collects input from the CDCM and relevant to LDNO volumes. These inputs are used in the calculation of discounted LDNO tariffs.

The following input tables are to be completed:

- **CDCM end user tariffs.** The CDCM tariffs (unit rate 1, 2 and 3, fixed, capacity, exceeded capacity and reactive power charges) are to be entered here for each customer, from "Output 102-B" in the CDCM model.
- **Fixed charge adders.** These fixed charge adders are calculated in the CDCM, and output as part of "Output 102-B".
- **0000 LDNO volume data.** Data for the rate 1, 2 and 3 units, MPANs, import capacity, exceeded capacity and reactive power units for each LV or HV customer connected to a 0000 LDNO are to be entered.
- **132kV LDNO volume data.** Data for the rate 1, 2 and 3 units, MPANs, import capacity, exceeded capacity and reactive power units for each LV or HV customer connected to a 0000 LDNO are to be entered.
- **132kV/EHV LDNO volume data.** Data for the rate 1, 2 and 3 units, MPANs, import capacity, exceeded capacity and reactive power units for each LV or HV customer connected to a 132kV/EHV LDNO are to be entered.

- **EHV LDNO volume data.** Data for the rate 1, 2 and 3 units, MPANs, import capacity, exceeded capacity and reactive power units for each LV or HV customer connected to an EHV LDNO are to be entered.
- **HVplus LDNO volume data.** Data for the rate 1, 2 and 3 units, MPANs, import capacity, exceeded capacity and reactive power units for each LV or HV customer connected to a HVplus LDNO are to be entered.

This sheet also contains one piece of fixed input data, which is the mapping of customer tariff types to discounts. This is included on this sheet, rather than the fixed inputs sheet, in order to achieve a consistent structure later in the model. This should not be modified by the user.

7. CALCULATIONS

The sections in the calculation sheets are labelled using the same numbering convention used for the input tables. For example, a section with the value 302-C would represent the third section, on the second calculation sheet in the EDCM.

The calculations in the EDCM-FCP model can be split into four high-level sections that flow from one to the next:

1. Input pre-processing
2. Charge pre-processing
3. Charge calculations
4. Discount and revenue calculations

These sections, and the sheets within each, are illustrated in the model map, reproduced here.

7.1. Input pre-processing

The calculations in this section pre-process some of the inputs to calculate parameters which are used extensively throughout later parts of the methodology.

7.1.1. "Capacities" sheet

This sheet processes import and export capacities and related parameters for each tariff and carries out a range of adjustments to these capacities and parameters.

Annual and super-red adjustments

In many aspects of the methodology, calculations are multiplied by a factor to account for the number of days in the year and the number of super-red hours for which connectees are customers.

These calculations refer to named ranges for the number of days in the year and the number of super-red hours in the year.

kW/kVA adjustments

The average super-red kW import per kVA capacity parameter is modified in different ways for use in different parts of the model.

For the calculation of network asset values in the import capacity charge (described in DCUSA Paragraph 15.11), this parameter is *multiplied by a loss adjustment factor*. This loss adjustment factor is determined based on which customer category the customer belongs to. Nested INDEX() and MATCH() formulae are used to identify:

1. the network level to use for loss adjustment for each customer

2. the loss adjustment factor for the network level for each customer

When combined, INDEX() and MATCH() behave similarly to Excel's VLOOKUP function. The MATCH() function returns the position, n, within a range of data at which a specific value can be found. The "0" in the match function signifies that Excel will look for an exact match. The INDEX() function then returns the nth value from another range. These functions refer to parameters on the "Fixed inputs" sheet. Named ranges have been used to aid comprehension.

In the calculation of transmission charges (described in DCUSA Paragraph 9.3), this parameter is adjusted further for customers that are connected for only part of the year. As clarified with DNO Parties, this calculation takes the following form:

$$\begin{aligned} & \left[\text{Loss adjusted } kW/kVA, \text{ part - year} \right] \\ & = \left[kW/kVA \right] \times LAF \times \frac{\left[\% \text{ of super - red hours as a customer} \right]}{\left[\% \text{ of days as a customer} \right]} \end{aligned}$$

When calculating the adjustment to the super-red unit rate (described in Schedule 17/18 Paragraph 19.7 of the DCUSA) and the exceeded import capacity charge (described in Schedule 17/18 Paragraph 20.9), the average super-red kW/kVA adjusted for part-year connections is used, without also adjusting for losses. This is equivalent to the calculation above, but with the loss adjustment factor equal to 1.

Import capacities

A DSM ratio is calculated, as:

$$DSM \text{ ratio} = \frac{\left[\text{Maximum import capacity} \right] - \left[\text{DSM capacity} \right]}{\left[\text{Maximum import capacity} \right]}$$

This DSM ratio is used to scale the FCP/LRIC charges for customers who have DSM agreements. For customer without DSM agreements, the DSM ratio will be 1.

The maximum import capacity is adjusted for part-year connected customers as:

$$\begin{aligned} & \left[\text{Maximum import capacity, part - year} \right] \\ & = \left[\text{Maximum import capacity} \right] \times \left[\% \text{ of days as a customer} \right] \end{aligned}$$

If customers have a maximum import capacity of zero, a flag of "FALSE" is used to ensure that those customers do not have any import tariffs.

Export capacities

Export capacities are adjusted for part-year connected customers:

$$\left[\text{Export capacity, part - year} \right] = \left[\text{Export capacity} \right] \times \left[\% \text{ of days as a customer} \right]$$

This is done for:

- Exempt export capacity.

- Non-exempt pre-2005 export capacity.
- Non-exempt 2005-2010 export capacity.
- Non-exempt post-2010 export capacity.
- Capacity eligible for GSP generation credits.

There are three categories of non-exempt export capacity. This is required by the form of the export capacity charge calculation in Schedule 17 Section 12. The total sum of these three capacities is the chargeable export capacity.

The sum of chargeable export capacity and exempt export capacity is the maximum export capacity.

Table 7.1 summarises all of the values which are exported from the capacities sheet and the sheets to which they are exported. This is represented as a matrix in order to simplify the presentation. As can be seen, the calculations on this sheet are used extensively throughout the model.

Table 7.1: Summary of values exported from the “Capacities” sheet

Values exported	Charge 1 (LRIC)	Charge 1 (FCP)	Transmission	Export super-red	Export capacity	Import capacity	Import super-red	Fixed	Import exceeded	Export exceeded	Revenue
Days of the year as a customer							1		1		
Proportion of the year as a customer						1		1			
Hours in super-red for which a customer							1		1		1
Proportion of super-red hours as a customer						1					
Has import charges?						1	1	1	1		
Maximum import capacity adjusted for part year	1	1	1			1		1	1		1
Chargeable import capacity adjusted for part year									1		
DSM Ratio	1	1					1		1		
Has export charges?				1	1			1		1	
Maximum export capacity adjusted for part-year	1	1		1	1			1			
Chargeable export capacity adjusted for part-year	1	1		1	1			1			
Exempt export capacity adjusted for part-year					1			1			
Capacity eligible for GSP generation credits adjusted for part year					1						
Non-exempt 2005-2010 export capacity adjusted for part-year					1						
Non-exempt post-2010 export capacity adjusted for part-year					1						

Values exported	Charge 1 (LRIC)	Charge 1 (FCP)	Transmission	Export super-red	Export capacity	Import capacity	Import super-red	Fixed	Import exceeded	Export exceeded	Revenue
Non-exempt pre-2005 export capacity adjusted for part-year					1						
Average kW/kVA adjusted part year							1		1		
Loss adjusted peak-time kW/maximum kVA						1					
Loss adjusted peak-time kW/maximum kVA adjusted for part year			1								

7.1.2. “Asset values” sheet

The Asset values sheet performs calculations relating to the voltage levels in the model. The outputs from the Asset value calculations table are used in the calculation of network asset rates, total asset values within the model and the active power equivalent. These are used in the calculation of the import capacity charge.

Total asset values

The total asset values are calculated by mapping assets in the CDCM model at each voltage level to three groups:

- EHV assets (comprising 132kV circuits, 132kV/EHV, EHV circuits, EHV/HV, 132kV/HV)
- HV and LV network assets (comprising HV circuits, HV/LV, LV circuits)
- HV and LV service model asset (comprising LV and HV customer assets)

Asset rate calculations

Calculations of asset rates is carried out in this section, based on the method used in the CDCM. These are required in the calculation of network asset values as described in Paragraph 15.11.

For each voltage level, the asset rate calculation is:

$$[\text{Network asset rate}] = \frac{[\text{Assets in CDCM model}]}{[\text{System simultaneous maximum load}] \times [\text{LAF}]}$$

For 132kV/HV assets, an override asset rate can be entered in the inputs. If this is entered, then this is applied on this sheet.

Active power equivalent

The active power equivalent, as used in Paragraph 15.11, is calculated on this sheet for each voltage level. This is the product of the power factor in the CDCM 500 MW model³ (0.95) and the loss adjustment factor to transmission for that network level.

Table 7.2: Summary of values exported from the “Asset values” sheet

Destination sheet	Values exported
Import capacity	EHV assets HV and LV network assets HV and LV service model assets Adjusted network asset rate Active Power Equivalent

³ See CDCM Model User Guide for a description of this.

7.2. Charge pre-processing

This section describes the sheets which pre-process some of the charge inputs, including the cost-reflective charges and the calculation of transmission tariffs.

7.2.1. “Charge 1 (LRIC)” sheet

This sheet is not used in the EDCM-FCP model.

7.2.2. “Charge 1 (FCP)” sheet

This sheet processes the Charge 1 from the FCP model. This largely corresponds to Schedule 17, Section 6 of the legal text.

This sheet uses combined INDEX() and MATCH() functions, as described in Section 7.1.1. These functions refer to parameters on the FCP inputs sheet. Named ranges have therefore been used to aid comprehension.

Cell H27 automatically enables or disables some of the calculations on this sheet within the FCP model. This would be automatically set to 0 within the LRIC model in order to disable the functionality within this sheet. In the FCP model, it is automatically set to 1.

Identification of FCP parent and grandparent group

Each tariff is associated with an FCP network group, which may also have a parent and grandparent group. The means by which the model identifies FCP groups is illustrated in Figure 7.1.

Figure 7.1: Overview of method for identifying FCP parent and grandparent groups

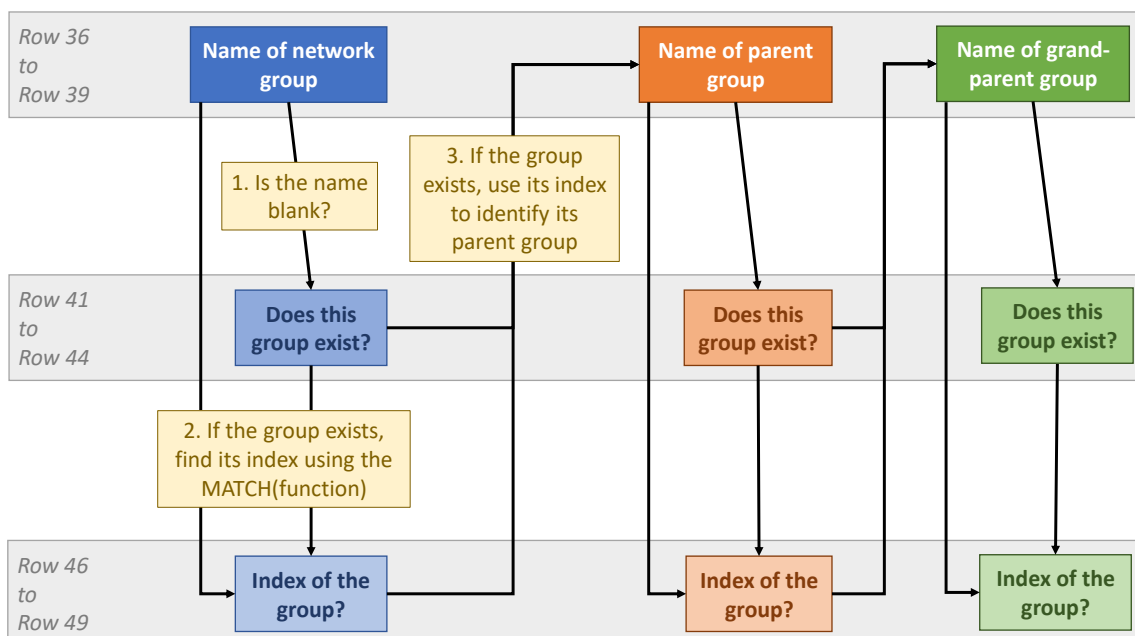

The model implements the following process for each location:

1. If the group name is blank, the model returns a FALSE flag to signify that the group doesn't exist.
2. If the group does exist, the model determines its position within the full list of groups, i.e. its index, using the MATCH() function. The full list of groups is stored within the FCP_Group_Name named range. The third argument of the MATCH function is set to zero so that the model will look for an exact match. This index is used in several of the other calculations on this sheet.
3. If the group exists (with the model returning a TRUE flag), then the model will use the index of this group to identify the parent group from the FCP_Parent_Group, using the INDEX() function. If the tariff does not have a parent group, the model will return a zero.

This process is repeated for all of the groups. To help improve the overall structure and flow of calculations, the names of all of the groups and parent groups are kept together in a single table in Rows 36 to 39 of the "Charge 1 (FCP)" worksheet. This is also true of the TRUE/FALSE flag for each location and their indices. As a result, the entries in the group name table refer to cells below, rather than just cells above, as shown in Figure 7.2.

The total number of locations for each tariff is computed by adding together all of the TRUE/FALSE flags. Excel interprets each TRUE statement as a "1" and each FALSE statement as a "0".

Figure 7.2: Parent groups formula referring to cells below

Group name, by level		
Network	text	Network group
Parent	text	=IF(L42, INDEX(
Grandparent	text	FCP_Parent_Group, L47), 0)
Does this group exist, by level		
Network	TRUE/FALSE	TRUE
Parent	TRUE/FALSE	TRUE
Grandparent	TRUE/FALSE	TRUE
Group number, by level		
Network	integer	1.00
Parent	integer	2.00
Grandparent	integer	3.00

FCP maximum demand calculations

The power flow characteristics of each customer are calculated within the model. The super red kW import divided by kVA capacity and super-red kVA import divided by kVA capacity are brought into the sheet. A flag records whether the kW/kVA parameter is zero for each tariff.

The super red kVAr import divided by kVA capacity is adjusted such that the implied combined active (kW) and reactive (kVAr) power demands do not exceed the total apparent (kVA) power demands. In other words, so that:

$$\sqrt{\left(\frac{kW}{kVA}\right)^2 + \left(\frac{kVAr}{kVA}\right)^2} \leq 1$$

Which is equivalent to:

$$\sqrt{kW^2 + kVAr^2} \leq kVA$$

This is in accordance with the final sentence of DCUSA Schedule 17 Paragraph 6.2:

“The average kVAr divided by kVA is restricted to be such that the combined active and reactive power flows cannot exceed the Maximum Import Capacity”.

This is implemented using the following steps.

1. The absolute value of the maximum kVAr/kVA value that would be possible is determined:

$$\left[Max\ kVAr/kVA_{ABS}\right] = \sqrt{1 - MIN(1, [kW/kVA])^2}$$

This is the absolute value, as the square root only returns a positive value and the kVAr/kVA parameter could take a negative value.

Any kW/kVA values greater than one (which might apply if a customer is forecast to exceed their maximum capacity during super-red periods) are set to a maximum value of 1 for the purposes of this calculation with the MIN() function.

2. Calculating the actual adjusted super-red kVAr import by kVA capacity:

$$\begin{aligned} & \left[kVAr/kVA, adjusted\right] \\ & = MIN\left(ABS\left(\left[kVAr/kVA\right]\right), \left[Max\ kVAr/kVA_{ABS}\right]\right) \\ & \times SIGN\left(\left[kVAr/kVA\right]\right) \end{aligned}$$

The MIN() function returns the absolute value of the kVAr/kVA parameter, capped to the maximum calculated in the previous step. Multiplying through by the sign of the original parameter then ensures the direction of the peak-time reactive power flow is preserved.

For each tariff, the power factor and a “reactive power factor” for both the parent and grandparent group need to be calculated. This is done on the kW and kVAr demand and generation power flows arising from the FCP models. These kW and kVA flows are identified using the INDEX function and based on the index for each group calculated previously.

The total kW and kVAr flows are determined as the sum of the demand and generation flows. In addition, the total apparent (kVA) power flow is calculated as

$$[kVA \text{ flow}] = \sqrt{[kW \text{ flow}]^2 + [kVAr \text{ flow}]^2}$$

If both the active power and reactive power for the parent group (or grandparent group) are equal to zero then the power factor is set to 1 and the reactive power factor is set to 0.

Otherwise these are calculated as:

$$\text{Power factor} = \frac{ABS([kW \text{ flow}])}{[kVA \text{ flow}]}$$

$$\text{Reactive power factor} = \frac{-[kVAr \text{ flow}]}{[kVA \text{ flow}]}$$

Charge 1 calculation

The unbounded local charges are identified at each location, again using the INDEX() function and the index previously identified for each location.

The MAX() function is used to set any negative charges to zero (labelled the “bounded” local charge).

Super-red charge calculation

As required within the DCUSA legal text, separate calculations are carried out for the case where the average kW/kVA = 0 and the case where it is not equal to 0.

The super-red rate elements are calculated separately for the parent and grandparent group and then added together, following the forms set out in the DCUSA legal text. Within the total, negative contributions from either the parent or grandparent group are set to zero using Excel’s MAX() function.

The TRUE/FALSE flag on whether average kW/kVA = 0 is then used to select which of the super-red rates should apply.

Capacity charge calculation

As required within the DCUSA legal text, separate calculations are carried out for the case where the average kW/kVA = 0 and the case where it is not equal to 0.

The capacity charge rate elements are calculated separately for the network, parent and grandparent group and then added together, following the forms set out in the legal text. Within the total, negative contributions from either the parent or grandparent group are set to zero using Excel’s MAX() function. In the case where average kW/kVAr is not equal to zero, only a network group element is calculated.

The TRUE/FALSE flag on whether average kW/kVA = 0 is then used to select which of the capacity charges should apply.

Calculation of capacity charge 1

The charge 1 element of the capacity charge is calculated as the product of the capacity charge (as described above) and the DSM ratio (the ratio of chargeable capacity and maximum capacity, as calculated on the “Capacities” sheet).

Calculation of revenue from capacity charge 1

The total forecast revenue to be recovered from each customer from the charge 1 element of the capacity charge is calculated as the product of the charge and the part-year adjusted maximum import capacity. This is summed across all customers to produce a total revenue.

Calculation of super-red export charge 1

The super-red export rate is calculated following the formula set out in DCUSA Schedule 17 Paragraph 6.3. The network group, parent group and grandparent group charges are added together and multiplied by the following parameters:

- The number of pence in the pound (to convert from £ to p).
- The ratio of maximum export capacity to chargeable export capacity (to account for customers with exempt export capacity).
- The proportion eligible for charge 1 credits (to remove super-red export credits for ineligible customers).
- Divided by the number of super-red-hours in the year, to convert from a per year charge to a per hour charge.

If the maximum export capacity is zero, the super-red export rate is set to zero.

Any negative network group, parent group or grandparent group charges are set to zero in this calculation.

Table 7.3: Summary of values exported from the “Charge 1 (FCP)” sheet

Destination sheet	Values exported
Import exceeded	Capacity charge Super-red rate
Import capacity	Charge 1 capacity charge
Import super-red	Super-red rate
Export super-red	Super-red export rate

7.2.3. “Transmission” sheet

This sheet calculates the transmission connection exit charges for demand, the total EDCM peak time consumption and the revenue to be recovered from these charges. It also calculates

the transmission exit charging rate, which is later used to calculate transmission connection exit credits for generators.

Table 7.4: Summary of values exported from the “Transmission” sheet

Destination sheet	Values exported
Export capacity	Transmission exit charging rate
Import capacity	Transmission exit charge

Capacities calculations

In this section the values of the maximum import capacity and the loss adjusted peak-time kW/maximum kVA, both adjusted for part year, are imported from the Capacities tab for each connectee. The sum product of these values is calculated in the next section and this represents the total EDCM peak time consumption.

Transmission connection (exit) charges for demand

The total transmission exit charges which the DNO pays to National Grid and the total load connected to the DNO network are imported from the General inputs tab. This allows the transmission exit charging rate in £/kW/year to be calculated in accordance with Schedule 17 Paragraph 9.2:

$$[\text{Transmission exit charging rate}](\text{£/kW/year}) = \frac{E(\text{£ per year})}{L(\text{kW}) + C(\text{kW})}$$

Where E is the total DNO expenditure on transmission exit charges, L is the system simultaneous maximum load in the CDCM, and C is the total EDCM peak time consumption.

Following Schedule 17 Paragraph 9.3, this value is then converted into a p/kW/day value. This single charging rate is converted into an import capacity-based charge for each EDCM connectee by multiplying by their loss adjusted peak-time kW/maximum kVA.

7.3. Charge calculations

7.3.1. “Export super-red” sheet

The “Export super-red” sheet takes the export super-red charge calculation from the Charge 1 (LRIC)/(FCP) sheet⁴ and ensures this is zero for customers with export charges and the charge is rounded to the number of decimal places specified in the DCUSA legal text.

This sheet is also used to determine the amount of revenue which is forecast to be recovered by this charge. For each customer, this is calculated as the product of the rounded super-red export rate and the number of super-red units forecast to be exported (which is entered on the Tariff inputs sheet).

⁴ This calculation is done on the preceding sheet in order to simplify the model.

Table 7.5: Summary of values exported from the “Export super-red” sheet

Destination sheet	Values exported
EHV tariffs	Super-red export rate (rounded)
Revenue	Revenue from super-red units Total revenue from super-red units

7.3.2. “Export capacity” sheet

This sheet calculates the export capacity charges using the formulae prescribed in Paragraph 12. The transmission exit credits (for eligible generators) are also calculated on this sheet as these feed into the export capacity charges. The revenue recovered through the export capacity charge is also calculated, referred to as the EDCM Distributed Generation (DG) Revenue Target.

Table 7.6: Summary of values exported from the “Export capacity” sheet

Destination sheet	Values exported
EHV tariffs	Export capacity charge (rounded)
Export exceeded	Export capacity charge excluding transmission credits for each site
Import capacity	Total revenue from export capacity charge
Revenue	Revenue from export capacity charge Total revenue from export capacity charge

Export capacity calculations

The export capacities for each connectee and the total CDCM generation capacity are brought in from other sheets. The total EDCM chargeable capacities are calculated by summing over export capacities which have been brought in from other sheets. The transmission exit charging rate is imported from the Transmission sheet and the transmission exit credit for each connectee is calculated in accordance with Schedule 17 Paragraph 10.3:

$$\begin{aligned}
 & [Transmission\ exit\ credit] \\
 = & \frac{-[Transmission\ exit\ charging\ rate] \times [Capacity\ eligible\ for\ credits]}{[Chargeable\ export\ capacity]}
 \end{aligned}$$

The EDCM DG revenue target is then calculated following the equation in DCUSA Schedule 17 Paragraph 12.2. This equation has been separated into multiple stages in the model; the relevant values, such as the incentive revenue (GL), average of the amount of Use of System Capex for DG that is subject to the pass-through arrangement of the Incentive Scheme (AGPa) and the allowance for operational and maintenance costs (OM), are imported. The GL based revenue, AGPa based revenue and OM revenue are calculated, from these values and finally, the DG revenue target can be calculated:

$$[DG\ revenue\ target] = [GL\ based\ revenue] + [AGPa\ based\ revenue] + [OM\ revenue]$$

The export capacity charges excluding transmission exit credits for each site is calculated by dividing the EDCM DG revenue target (which is in £ per year) by the total chargeable export capacity and converting this into a p/kVA/day value. The transmission exit credits are then added to this value to produce the final export capacity charge.

Revenue from export capacity charge

Based on the calculations of the export capacity charge, this section calculates the total revenue to be recovered from this charge.

$$[Revenue] = [Export\ capacity\ charge] \times [Chargeable\ export\ capacity] \times \frac{[days\ in\ year]}{[pence\ in\ pound]}$$

This produces a £ per year value per site, which is aggregated across all connectees to calculate the total revenue to be generated from the export capacity charge.

7.3.3. “Import capacity” sheet

This sheet calculates all of the elements of the import capacity charge including the elements from Charge 1, the transmission exit charge, a network rates and direct operating cost charge, an indirect operating costs charge, and then two residual revenue charges (one based on network assets and a fixed adder).

The network rates and direct operating costs charge and the asset-based residual charge are calculated based on the relative value of each user’s shared network assets.

The indirect operating costs charge and the residual fixed adder are calculated based on a user’s coincidence with system peak demand.

The steps in the calculation of the import capacity charge are:

1. Calculate the notional value of the assets needed to provide capacity and to serve demand for each customer, then aggregate this across all customers.
2. Derive contribution rates for different categories of expenditure, as the ratio of total expenditure of various types to an asset base value.
3. From steps 1 and 2, determine a revenue target for EDCM demand tariffs.
4. Calculate again the notional value of the assets needed to provide capacity and to serve demand for each customer but subject this to a cap and a collar.
5. Calculate tariff components for different categories of expenditure.
 - a. Direct operating costs and network rates charge
 - b. Indirect operating costs charge
6. Combine these with the transmission tariff and the Charge 1 tariff to determine the overall import capacity charge.

The following subsections describe these steps in more detail.

1. Site specific shared network assets

In order to determine the contribution rates, it is necessary to determine the total value of shared assets within the EHV network. Notional asset values are calculated for the assets which each customer is deemed to use due to:

- The DNO providing them with year-round kVA capacity.
- Their instantaneous kW demand during system peak.

This element of the calculation only considers ‘shared’ network assets – i.e. those assets that are not for the sole use of any customer (the costs of which are recovered through the fixed charge).

Whether or not each customer uses each of the EHV voltage levels is described by Table 15.9 of Schedule 17 of the DCUSA legal text. This is reproduced in the model on the Fixed inputs sheet in Input 301-F and Input 301-G. The rule of thumb is that customers use the network level to which they are connected in order to gain capacity (i.e. to access the network) and use the network levels above in order to serve their instantaneous demand (i.e. to enable their usage).

This part of the calculation also considers modified versions of the network asset rates calculated on the “Asset Values” sheet.

For capacity, the form of the calculation for each voltage level is:

$$\begin{aligned} & [\textit{Network asset value for capacity}] \\ & = [\textit{Network asset rate}] \times \frac{[\textit{Active Power Equivalent}]}{1 + [\textit{Diversity Allowance}]} \end{aligned}$$

The active power equivalent is the product of the loss adjustment factor (for each network level) and the 0.95 power factor from the CDCM 500 MW model.⁵

For demand, the form of the calculation for each voltage level is:

$$\begin{aligned} & [\textit{Network asset value for demand}] \\ & = [\textit{Network asset rate}] \times [\textit{Loss adjusted kW/kVA}] \end{aligned}$$

Both of these calculations related to network asset value are carried out for each customer.

The network asset rates are then combined with the mapping in Paragraph 15.9 and the Network Use Factors (calculated as an input into the model) in order to determine a site-specific asset value for capacity and a notional asset value for demand for each customer at each voltage level.

Both of the £/kVA asset values (for capacity and demand) are aggregated across all of the voltage levels and combined for each customer. The values for demand are adjusted to

⁵ See CDCM Model User Guide for a description of this.

account for the proportion of super-red hours and the proportion of days for which they are connected in the year.

The total value of site-specific/notional shared assets across all customers is then determined by multiplying the £/kVA asset value by each customer's maximum import capacity and aggregating this across all customers.

2. Calculation of the EDCM Demand Revenue Target

As an input to the model, the DNO enters the total amount of revenue to be recovered from all use of system charges, as well as the total expenditure on network rates, direct operating expenditure and indirect operating expenditure. This covers customers connected to the EHV, HV and LV networks. The model then calculates the shares of this total allowed revenue target to be recovered within the EDCM.

This is done based on:

1. The total values of different types of assets, including the site specific/notional shared assets described in the previous subsection.
2. Contribution rates; percentages which measure the number of £s of expenditure incurred per £ of asset value

The asset values which may be used in the calculation of the contribution rate are:

- a) The total value of EDCM site/specific notional shared assets
 - This is calculated as described in the previous subsection
- b) The total value of EDCM sole-use assets (for both demand and generation)
 - The allocation of sole-use asset value to demand and generation takes place on the "Fixed" sheet. These asset values are then adjusted for part-year connected customers.
- c) The total value of EHV assets from the CDCM
 - This is calculated on the asset values sheet
- d) The total value of HV and LV service model assets from the CDCM
 - This is calculated on the asset values sheet
- e) The total value of HV and LV network assets from the CDCM
 - This is calculated on the asset values sheet

For network rates, the contribution % is calculated as:

$$[\text{Network rates contribution \%}] = \frac{[\text{Network rates expenditure}]}{(a) + (b) + (c) + (d) + (e)}$$

For direct and indirect operating costs, the contribution % is calculated as:

$$[\text{Operating cost contribution \%}] = \frac{[\text{Operating cost expenditure}]}{(a) + (b) + (c) + \frac{(d)}{0.68} + \frac{(e)}{0.68}}$$

Both categories of HV and LV asset cost are divided by 0.68 (the operating intensity factor). This reflects the fact that the HV and LV networks tend to incur more operating cost on the HV and LV network than on the EHV network.

$$[\text{residual revenue contribution \%}] = \frac{[\text{Residual revenue expenditure}]}{(a) + (c) + (e)}$$

EHV sole-use assets and HV and LV service model assets are not considered in the calculation of the residual revenue contribution %. This reflects the intention that residual revenue should only be associated with shared assets.

Residual revenue expenditure is calculated within the model as the DNO's total allowed revenue less the amount of direct costs, indirect costs, network rates, and total revenue recovered from EDCM export charges. The total revenue from each category of EDCM export charge is calculated on preceding sheets and summed on the "Import capacity" sheet as "total forecast net revenue from EDCM export charges".

3. Calculation of the EDCM Demand Revenue Target

From these contribution rates, the model calculates the contribution each user makes towards each category of expenditure.

- For site-specific shared network assets, a contribution to network rates, direct operating cost, indirect operating cost and residual revenue is calculated as the product of maximum import capacity, the £/kVA asset value, and the contribution rate.
- For sole-use assets allocated to demand, a contribution to network rates, direct operating cost, and indirect operating cost is calculated as the product of the demand sole-use asset values, and the contribution rate.
- These are aggregated across all users to determine total contributions to each category of expenditure to be recovered from the EDCM.

The EDCM demand revenue target is calculated as the sum of the total contributions to all of these categories of expenditure.

A correction is applied to the EDCM demand revenue target to account for the reduction in fixed charges that applies due to capitalised O&M payments. The reduction in revenue due to capitalised O&M payments is calculated on the Fixed sheet (this is labelled as "OMR" within Schedule 17). The reduction to the EDCM demand revenue target (labelled as "FCR" within Schedule 17) is then calculated as:

$$[FCR] = [OMR] \times$$

$$\frac{[EHV \text{ assets}] + [HV \text{ and LV network assets}]}{[Total \text{ site – specific shared assets}] + [EHV \text{ assets}] + [HV \text{ and LV network assets}]}$$

4. Recalculation of shared network asset values

The calculation of site specific shared network asset values (described in the “Site specific shared network assets” subsection) is repeated, except with each network use factors subjected to a cap (a maximum value) and a collar (a minimum value). For each network level, for capacity and demand, the adjusted site-specific asset values are calculated as the product of the adjusted network use factor, the network asset rate, and the mapping in Paragraph 15.9. These are then aggregated as before to determine a total adjusted site-specific network asset value. The asset value for demand is, as before, adjusted for part-year connections.

The total adjusted value of site-specific network assets aggregated across all customers is used in the calculation of two “asset-based” elements of the import capacity charge:

- The direct operating costs and network rates charge.
- The asset-based residual revenue charge.

These calculations are described below.

5a. Direct operating costs and network rates charge

Charging rates in percentages are derived for direct operating costs and network rates. This is done by dividing the total expenditure on these costs associated with EDCM site-specific shared network assets by the adjusted value of site-specific shared network assets.

For each user, these charging rates are added together and then multiplied by the user’s total adjusted site-specific shared asset value in order to determine the direct operating costs and network rates charge. This charge is converted from £/kVA/day into p/kVA day.

The calculation of this charge is essentially allocating expenditure on direct operating costs and network rates to users on the basis of the relative value of the shared network assets which they use.

5b. Indirect operating cost charge

A £/kVA charge is determined based on the total expenditure on indirect costs. This charge shares this cost out amongst users based on their coincidence with system peak demand. A coincidence factor is calculated for each user, as:

$$[Coincidence \ factor] = \left[\frac{kW}{kVA} \right] \times \frac{[proportion \ of \ super \ - \ red \ hours]}{[proportion \ of \ days \ in \ the \ year]}$$

This is the same parameter as the assumed form of the kW/kVA parameter when adjusted for part-year connections.

A kVA volume for scaling is determined for each customer, as:

$$\begin{aligned}
 &[\textit{Volume for scaling}] \\
 &= (0.5 + [\textit{coincidence factor}]) \times [\textit{Maximum import capacity}] \\
 &\times [\textit{LDNO factor}]
 \end{aligned}$$

The LDNO factor is 1 for users who are connected directly to the DNO’s network, and 0.5 for users who are connected to an LDNO. This is entered on the “Tariff inputs” sheet as “proportion exposed to indirect cost allocation and fixed adder”. The model assumes this does not apply when the residual revenue is negative (as per Schedule 17 Paragraph 26.11).

The form of this equation means that all users make a £/kVA contribution to indirect costs, but that users who have a relatively higher usage during peak periods make a larger contribution.

The total expenditure on indirect costs (for both shared and sole-use assets) is divided by the total volume for scaling aggregated across all users to determine a £/kVA charging rate for indirect costs. This is used to determine an import capacity based indirect charge for each user as:

$$[\textit{indirect charge}] = [\textit{indirect cost charging rate}] \times (0.5 + [\textit{coincidence factor}])$$

The multiplication by the LDNO factor is applied in the final step of the import capacity charge calculation (see below).

6. Final Import capacity charge

In the event that residual revenue is positive, the import capacity based indirect charge is scaled down by 50% for customers who are connected to an LDNO. This is achieved by multiplying this tariff element by the LDNO factor when the “is residual revenue negative” flag is FALSE. Otherwise, the charge is not multiplied by the LDNO factor. This is in line with Schedule 17 Paragraph 26.11. The implementation in the model assumes that the scaling by 50% described in this paragraph is the same as the multiplication by the LDNO factor in Schedule 17 Paragraph 18.17.

All four of the elements of the of the import capacity charge are added together. These are bounded to zero using the MAX() function, so that no negative import capacity charges can exist. Finally, the import capacity charge is rounded to two decimal places.

Table 7.7: Summary of values exported from the “Import capacity” sheet

Destination sheet	Values exported
Revenue	Charge 1 capacity charge Transmission exit charge Network rates and direct costs charge Import capacity based indirect charge Rounded import capacity charge
Import super-red	Import capacity charge
Import exceeded	Bounded import capacity charge

Destination sheet	Values exported
EHV tariffs	Rounded import capacity charge

7.3.4. “Import super-red” sheet

This sheet adjusts the super-red charge for customers with DSM agreements and in the event that the import capacity charge is negative. The total revenue recovered from this charge is calculated and fed back into the import capacity sheet.

Table 7.8: Summary of values exported from the “Import super-red” sheet

Destination sheet	Values exported
Revenue	Import super-red unit rate rounded
Import capacity	Total revenue from non-adjusted super-red unit rate
EHV tariffs	Import super-red unit rate rounded

Calculation of import super-red rate

This section imports the necessary values from the input sheets, such as the adjustment factors, the import capacity charge and the super-red rate. The imported rate is before DSM adjustment, so the DSM ratio is also imported and these values are multiplied to obtain the super-red rate after adjustment.

The super-red rate is adjusted if the import capacity charge is negative and the average kW/kVA is not equal to zero, following the equation in Schedule 17 Paragraph 19.7:

$$\text{Adjusted super red rate} = \frac{[\text{super red rate}] + [\text{charge 1 import capacity charge}] \times [\text{Days of the year as a customer}]}{[\text{Average kW/kVA}] / [\text{Hours in super red for which a customer}]}$$

The effect of this adjustment is to recover the cost-reflective elements of the capacity charge (charge 1) through the super-red in the event that the overall import capacity charge is negative. If this adjustment was not made, then the customer would only be exposed to part of the cost-reflective charge 1 signal.

The import super red-rate is then set as the original super-red rate if the customer does not hold a DSM agreement and set as the adjusted super-red rate for customers who do hold an agreement. Any negative super-red unit rates are set to zero as per Schedule 17 Paragraph 19.8.

Import super-red revenue calculation

Based on the calculation of the import super-red unit rate and the import capacity of each connectee, the revenue from super-red charges is calculated. The maximum import capacity and the super-red kW import divided by kVA capacity are imported to this section. For each individual customer, the revenue from the non-adjusted super-red unit rate per customer is

calculated by multiplying these two imported quantities with the super-red rate and the hours in super-red for which a customer. This value is converted into £ per year units and then aggregated across all customers to obtain the total revenue.

7.3.5. “Residual bands” sheet

This sheet calculates the total metered import consumption for each of the four residual bands, as well as the number of final demand sites in each residual band. The count of final demand sites is repeated with scaling included for LDNO connected customers.

Table 7.9: Summary of values exported from the “Residual Bands” sheet

Destination sheet	Values exported
Residual charge	Metered import consumption per band, discounted for LDNOs Count final demand sites by residual band Count final demand sites by residual band, discounted for LDNO connectees

7.3.6. “Residual charge” sheet

This sheet calculates the residual charge for each band, by allocating residual revenue to the band based on its proportion of the total metered import consumption, and then sharing this between the customers in the band.

This sheet also determines whether, and how, any of the residual bands need to be combined together due to having an insufficient number of customers in any band.

Table 7.10: Summary of values exported from the “Residual Bands” sheet

Destination sheet	Values exported
Fixed charge	Residual to be added to fixed charge for final demand sites

7.3.7. “Fixed” sheet

This sheet calculates the import and export fixed charges for sole use assets. This charge covers: (i) the customer’s contribution towards the network rates and direct costs associated with the sole use assets; and (ii) residuals. The first part of the charge is calculated based on modern equivalent asset values (MEAV) and the contribution rates calculated as part of the import capacity charge. The total asset values and fixed charges on sole-use assets (as well as the fixed charge reduction due to capitalised O&M) are fed back into the import capacity sheet.

Table 7.11: Summary of values exported from the “Fixed” sheet

Destination sheet	Values exported
Revenue	Revenue recovered from import sole use charge Revenue recovered from export sole use charge Total recovered from import sole use charges Total recovered from export sole use charges

Destination sheet	Values exported
Import capacity	MEAV of sole use assets allocated to demand MEAV of sole use assets allocated to generation Total reduction in revenue due to capitalised O&M Total recovered from import sole use charges Total recovered from export sole use charges
EHV tariffs	Import fixed charge on sole use assets rounded Export fixed charge on sole use assets rounded

Modern equivalent asset values

Sole use asset values are input into the model in terms of Modern Equivalent Asset Values (MEAV), which is essentially an estimate of replacement cost. Sole use asset values are allocated to demand as:

$$\begin{aligned}
 & [\textit{sole use asset MEAV for demand}] \\
 & = [\textit{sole use asset MEAV}] \\
 & \times \frac{[\textit{maximum import capacity}]}{[\textit{maximum import capacity}] + [\textit{chargeable export capacity}] + [\textit{exempt export capacity}]}
 \end{aligned}$$

Sole use asset values are allocated to generation as:

$$\begin{aligned}
 & [\textit{sole use asset MEAV for generation}] \\
 & = [\textit{sole use asset MEAV}] \\
 & \times \frac{[\textit{chargeable export capacity}]}{[\textit{maximum import capacity}] + [\textit{chargeable export capacity}] + [\textit{exempt export capacity}]}
 \end{aligned}$$

Where a tariff has some exempt export capacity, a share of their sole-use asset MEAV will not be subject to fixed charges.

All capacities in these calculations are part-year adjusted capacities.

In addition, the MEAV of sole use assets for demand which are subject to capitalised O&M (labelled as SUA MEAVU in the legal text) is calculated, based on the input “Percentage of sole use assets where customer is entitled to reduction for capitalised O&M”. The MEAV of sole use assets for demand which aren’t subject to capitalised O&M (labelled as SUA MEAVP in the legal text) is calculated similarly.

Sole-use asset fixed charge calculation

Fixed charges are calculated based on the network rates contribution rate and the direct operating costs contribution rate, calculated as part of the capacity charge.

Within the model, the formulae in Paragraphs 17.1 and 17.2 of Schedule 17 are essentially combined, so that the demand fixed charge is determined as:

$$\begin{aligned}
 & [fixed\ charge] \\
 & = ([DOC\ rate] + [NR\ rate]) * [D\ SUA\ MEAVU] \\
 & \quad + [NR\ rate] * [D\ SUA\ MEAVP] * \frac{days\ in\ year}{pence\ in\ pound}
 \end{aligned}$$

If no demand sole use assets are subject to capitalised O&M, this simplifies to

$$\begin{aligned}
 & [demand\ fixed\ charge] \\
 & = ([DOC\ rate] + [NR\ rate]) * [D\ SUA\ MEAV] * \frac{days\ in\ year}{pence\ in\ pound}
 \end{aligned}$$

This ensures that where customers have already made a capitalised O&M payment for their demand sole-use assets, they do not make a contribution again to this O&M cost through their fixed charge.

Generation fixed charges are calculated as:

$$\begin{aligned}
 & [generation\ fixed\ charge] \\
 & = ([DOC\ rate] + [NR\ rate]) * [G\ SUA\ MEAV] * \frac{[days\ in\ year]}{[pence\ in\ pound]}
 \end{aligned}$$

Fixed charges are rounded to two decimal places.

Fixed charge reduction due to capitalised O&M

The total reduction in revenue due to capitalised O&M payments is calculated. This is the “OMR” term which is used in the calculation of the EDCM demand revenue target.

This is calculated by:

1. Recalculating the demand fixed charge *without* accounting for capitalised O&M payments.
2. Determining the reduction in fixed charges due to O&M payments, as the difference between the actual demand fixed charge and the charge calculated in (1).
3. Finding the reduction in revenue per tariff, as the reduction in the charge, multiplied by the proportion of the year spent as a customer, and then converted from p/day into £ per year.
4. Aggregating this across all tariffs.

Revenue from fixed charges

The total revenue recovered from fixed charges is estimated as the fixed charge, multiplied by the proportion of the year spent as a customer, and then converted from p/day into £ per year. This is then aggregated across all tariffs. This is done for both import and export fixed charges. This informs the calculation of the EDCM residual, used in the calculation of import capacity charges.

7.3.8. “Import exceeded” sheet

This sheet calculates the exceeded import capacity charges. The chargeable import capacity, import capacity charge, the DSM ratio, the average kW/kVA adjusted part year and the super-red rate and charge 1 capacity charge before DSM adjustment are imported into this sheet.

Table 7.12: Summary of values exported from the “Import exceeded” sheet

Destination sheet	Values exported
EHV tariffs	Exceeded import capacity charge rounded

The calculation for the exceeded capacity charge for connectees with DSM agreements is set out in Schedule 17 Paragraph 20.9:

$$\begin{aligned}
 [\text{Exceeded capacity charge DSM}] &= [\text{Import capacity charge}] + \\
 &\left([\text{Charge 1 capacity charge}] \right. \\
 &\quad \left. + [\text{super red rate}] \times \left[\text{Average } \frac{\text{kW}}{\text{kVA}} \text{ adjusted part year} \right] \right. \\
 &\quad \left. \times \frac{[\text{number of super red hours connected}]}{[\text{days in year as a customer}]} \right) \times (1 - [\text{DSM ratio}])
 \end{aligned}$$

If a customer does not hold a DSM agreement, the import exceeded capacity charge is equal to the import capacity charge.

The model assumes that the average kW/kVA parameter should be used in this calculation, as this is not explicitly stated in the legal text.

7.3.9. “Export exceeded” sheet

This sheet calculates the exceeded export capacity charges. The export capacity charge excluding transmission credits are imported for each connectee from the Export capacity sheet. If it is determined that a site has export charges, the export exceeded capacity rate is equal to this imported value, following Schedule 17 Paragraph 20.6.

Table 7.13: Summary of values exported from the “Export exceeded” sheet

Destination sheet	Values exported
EHV tariffs	Export exceeded capacity rate rounded

7.4. Discounts and revenue calculations

This section describes the calculation sheets used to discount the LDNO tariffs and then estimate the LDNO revenue, and also calculate the total EDCM revenue per customer and across all customers.

7.4.1. “LDNO calculations” sheet

This sheet calculates the discounted LDNO tariffs and also estimates the total revenue recovered from these tariffs.

Mapping of discount percentages to tariff types

LDNO discounts are input into the model for five LDNO boundaries for four different CDCM tariff categories. The five LDNO boundaries are:

- 0000
- 132kV
- 132kV/EHV
- EHV
- HVplus

The four CDCM tariff categories are:

- LV demand
- LV Sub demand or LV generation
- HV demand or LV Sub generation
- HV generation

LV demand covers the tariffs for customers connected directly to LV circuits:

- Domestic Aggregated or CT
- Domestic Aggregated (related MPAN)
- Non-Domestic Aggregated or CT
- Non-Domestic Aggregated (related MPAN)
- LV Site Specific
- Unmetered supplies

LV sub-demand or LV generation covers the tariffs for demand customers connected to HV/LV substations and generation customers connected to LV circuits:

- LV Sub Site Specific
- LV Generation Aggregated
- LV Generation Site Specific

HV-demand or LV sub generation covers the tariffs for demand customers connected to HV circuits and generation customers connected to HV/LV substations:

- HV Site Specific
- LV Sub Generation Aggregated
- LV Sub Generation Site Specific

HV-generation covers the tariffs for generation customers connected to HV circuits:

- HV Generation Site Specific

The asymmetry in the mapping between demand and generation accounts for the fact that, in the CDCM, generation customers do not contribute to costs at the network level to which they are connected. Therefore, for example, LV generation customers receive the same discounts as demand customers connected to HV/LV substations. This is set out in Paragraph 99 of Schedule 16. Note that, as listed in ANNEX A, we have assumed that these discounts also apply to reactive power charges.

This mapping is defined on the LDNO inputs sheet and is combined with the LDNO discount inputs in order to produce a discount percentage for each CDCM tariff for all five of the LDNO boundaries.

Discounted tariffs

Discounted charges are calculated as:

$$[LDNO\ charges] = [CDCM\ charge] \times (1 - [LDNO\ discount])$$

The model does this calculation for each element (unit rates, fixed charges etc) of each tariff, and repeats it for each of the LDNO boundaries.

Fixed charge adders and rounding

Fixed charge adders related to Supplier of Last Resort, Bad Debt Recovery, and COVID-19 Bad Debt adjustments are added to the charges after they have been discounted.

Then, each charge is rounded to the appropriate number of decimal places, as defined on the fixed inputs sheet (2 decimal places. for fixed, capacity, and exceeded capacity charges, 3 decimal places for unit rates and reactive power charges).

LDNO volumes and LDNO revenues

The LDNO forecasted volume data is imported into this sheet. This is combined with the calculated LDNO discounted tariffs in order to produce an estimate of revenue from each component of each LDNO discounted tariff.

The total revenue from each discounted tariff for each LDNO boundary is calculated. This is aggregated across all of the tariffs, and then across all of the boundaries to produce a total estimate of LDNO discounted tariff revenue.

7.4.2. “Revenue” sheet

The revenue sheet is used to calculate the revenue which is forecasted to be recovered by each tariff from each customer, and then aggregating this across all customers. This informs some of the outputs to the CDCM model and may also be useful to DNOs when assessing tariff calculations.

Revenue from import charges

The total revenue calculated from each of the import charges is either reported or calculated on this sheet. For some of the charges this total revenue has already been calculated for other aspects of the calculation, in which case it is just imported from other sheets. For other charges, this is calculated here.

- The revenue from the **import capacity** charge is calculated on this sheet as the product of the maximum import capacity (adjusted for part-year) and the rounded import capacity charge. This is then aggregated across all tariffs.
- The revenue from the **import super-red** charge is calculated on this sheet as the product of the hours the customer spends in the super-red period, their maximum import capacity (adjusted for part-year), their super-red kW import divided by kVA capacity, and the rounded super-red unit rate. This is then aggregated across all tariffs.
- The **import fixed** charge revenue from each customer and from all customers is imported into this sheet from the fixed sheet.
- No revenue is forecasted from the **import exceeded capacity** charge.

Based on each charge, the total revenue to be recovered from each customer individually and all customers on aggregate is calculated.

Breakdown of import capacity charge revenue

An estimate is made of the total amount of revenue which is recovered from each of the different elements of the import capacity charge, those elements being:

- Charge 1 capacity charge
- Transmission exit charge
- Network rates and direct costs charge
- Import capacity based indirect charge

The revenue contribution from each of these elements of the charge can only be estimated as the final import capacity charge is rounded after these individual elements are added together.

This estimate is made by:

- Finding the percentage contribution of each element of the charge to the total rounded import capacity charge.
- Finding the total percentage contribution of all of these elements. This is likely to be less than or greater than 100% due to rounding.
- Rescaling the % contributions from each element by dividing through by the total percentage. After this rescaling, the summed contribution from all of the rescaled elements will equal 100%.
- These rescaled % are multiplied by the total revenue recovered from the import capacity charge in order to estimate the revenue recovered by each element.
- The total revenue recovered from each element is aggregated across all customers. A TRUE/FALSE flag is included to check whether this matches the total revenue recovered from import capacity charges (as calculated in the previous subsection).

Revenue from export charges

The total revenue from each type of export charge is calculated on the “export super-red”, “export capacity” and “fixed” sheets respectively. That is because these revenue estimates are required in the derivation of the EDCM demand revenue target.

The total revenue amounts for each charge and the revenue for each charge for each customer are imported onto this sheet. The total export charge revenue for each customer and across all customer is calculated.

8. OUTPUTS

The output tables are labelled following the same consistent numbering convention used to for the input tables and calculation sections.

The EDCM-FCP model contains six output sheets:

8.1. EHV tariffs and EHV tariffs transposed

- **EHV tariffs.** This sheet collects the EHV tariffs calculated within the model, with individual tariffs in each column, including import and export tariffs:

Import tariffs

- Import fixed charge on sole use assets
- Import super-red unit rate
- Rounded import capacity charge
- Exceeded import capacity charge

Export tariffs

- Export fixed charge on sole use assets
 - Super-red export rate
 - Export capacity charge
 - Export exceeded capacity rate
- For ease of use for post processing, the import and export tariffs are also transposed on the **EHV tariffs transposed** sheet.

8.2. LDNO tariffs and LDNO tariffs transposed

- **LDNO tariffs.** This sheet collects the discounted LDNO tariffs calculated within the model, with individual tariffs in each column. The tariffs are further split between the LDNO categories:
 - 0000 LDNO
 - 132kV LDNO
 - 132kV/EHV LDNO
 - EHV LDNO
 - HVplus LDNO

And the charges:

- Unit rate 1

- Unit rate 2
- Unit rate 3
- Fixed charge
- Capacity charge
- Exceeded capacity charge
- Reactive power charge
- For ease of use for post processing, the LDNO tariffs are also transposed on the **LDNO tariffs transposed** sheet.

8.3. Revenue summary, revenue summary transposed, and other model outputs

- **Revenue summary.** This sheet summarises the revenues from different charges and the total revenues for each customer. This includes the revenue that will be generated from import tariffs, export tariffs, the revenue from the different charge components and the totals. The previous year charges are also provided here for comparison.
- For ease of use for post processing, the Revenue summary sheet is transposed on the **Revenue summary transposed** sheet.
- **Outputs to other models.** This sheet summarises the total asset values and the total revenues for inputting into the PCDM and CDCM respectively
 - The total revenue outputs for the CDCM should be inputted to the DNO's CDCM model on the "Other inputs" sheet
 - The total asset value output for PCDM should be inputted to the DNO's PCDM model on the "DNO inputs" sheet

ANNEX A ASSUMPTIONS LOG

The following table sets out a series of assumptions that have been made to produce the current version of the ECDM. The assumptions here help to clarify or serve to amend the version of DCUSA text and any DCPs noted in Section 1 of this user guide. Each assumption has been approved by DCUSA Ltd with the consent of DNOs.

Table A.1: Assumptions

DCUSA text reference	Assumption	Worksheet reference	Description
Schedule 17 Section 2	FCP inputs	FCP inputs	The model assumes that this is only relevant to the calculation of the power flow inputs.
Schedule 17 Paragraph 6.2	Power flow inputs	FCP inputs	The model assumes that demand flows are entered as a negative value and that generation flows are entered as a positive value.
Schedule 17 Paragraph 6.2	Generation and demand power flow inputs	Charge 1 (FCP)	The model assumes that where generation and demand power flow inputs are entered separately, these should be added together before carrying out the calculations described.
Schedule 17 Paragraph 6.2	Super-red rate calculation	Charge 1 (FCP)	The model assumes that the calculation of the super-red rate for all other connectees should have the open brackets before the terms R1 and R2 removed.
Schedule 17 Paragraph 6.2	Negative contributions	Charge 1 (FCP)	The model assumes that the sentence “Any negative contributions to the [p/kVA/day capacity charge] or the [p/kWh super-red rate] from the parent or the grandparent network groups are set to zero.” means that after calculating the network group, parent group and grandparent group elements of each charge, any of these that are negative are set to zero.
Schedule 17 Paragraph 8.3	DSM adjustment	Charge 1 (LRIC)/Charge 1 (FCP), Import super-red	The model assumes that the DSM adjustment can be made to the charges as calculated in Schedule 17 Section 6, rather than to the “raw” FCP/LRIC inputs in order to simplify the modelling. This is because the charges are ultimately linearly dependent on the FCP/LRIC charge inputs.

DCUSA text reference	Assumption	Worksheet reference	Description
Schedule 17 Paragraph 8.3	Super-red DSM adjustment	Import super-red	The model assumes that “the DSM-adjusted remote (or parent and grandparent) element of the FCP charge 1 is applied to units consumed during the super-red time band” means that the super-red import charge is adjusted for DSM.
Schedule 17 Paragraph 9.2	Part-year adjustment	Capacities, Transmission	The model assumes that the adjustment for part-year referenced in this paragraph will apply to both the kW/kVA parameter and maximum import capacity.
Schedule 17 Paragraph 9.2	kW/kVA part-year adjustment	Capacities	For a part-year adjustment to super-red kW/kVA, the model assumes that this is calculated by multiplying by the proportion of super-red hours as a customer and dividing by the proportion of the year as a customer.
Schedule 17 Paragraph 9.2	Losses to transmission adjustment	Transmission	The model assumes the losses to transmission adjustment only applies to the kW/kVA parameter.
Schedule 17 Paragraph 10.3	Part-year adjustment	Capacities	The model assumes that both chargeable capacity and the capacity eligible for GSP credits should be adjusted for part-year connected customers.
Schedule 17 Paragraph 12.2	Part-year adjustment to capacity	Capacities	The model assumes that the part-year adjustment to the capacity described here, and all other part-year adjustments to capacity, simply involve multiplying the capacity by the proportion of the days in which the customer is connected.
Schedule 17 Paragraph 15.11	Network asset rate calculation	Asset values	The model assumes that the network asset rate at each voltage level is calculated as the asset values for that voltage level divided by the product of maximum demand at that voltage level and the loss adjustment factor to that voltage level.
Schedule 17 Paragraph 15.11	Peak time active power consumption in (kW/kVA)	Import capacity	The model assumes that this is a customer specific parameter and is equal to the average forecast super-red kW/kVA.

DCUSA text reference	Assumption	Worksheet reference	Description
Schedule 17 Paragraph 15.13	NUFs for mixed import-export sites that are generation-dominated	Tariff inputs	The model assumes that the calculation described in this paragraph is carried out prior to NUFs being input into the model.
Schedule 17 Paragraph 16.1, 16.10	Generation and transmission charge revenue.	Import capacity	The model assumes that generation revenue should be explicitly deducted from the calculation of the EDCM Demand Revenue Target, whereas that transmission charges should not be included in the overall revenue target and are therefore not deducted here.
Schedule 17 Paragraph 17.1, 17.2	Fixed charge calculation	Fixed	The model assumes that the formulae in Schedule 17 Paragraph 17.2 can supersede the one for import charges in 17.1, as when the capitalised O&M percentage is 0% they are equal.
Schedule 17 Paragraph 18.4-18.8	Network use factor cap and collar	General inputs	The model assumes that this is calculated elsewhere and entered as an input.
Schedule 17 Paragraph 18.16	Charging rate for indirect costs	Import capacity	The model assumes that the reference to "for each connectee" is incorrect and that this in fact is a single rate across all connectees.
Schedule 17 Paragraph 18.17	Multiplication by LDNO factor	Import capacity	The model assumes that the multiplication by the LDNO factor is the same as the scaling down by 50% as described in Schedule 17 Paragraph 26.11. Therefore, this multiplication is conditional on whether or not residual revenue is negative.
Schedule 17 Paragraph 19.5	Rounding	Import capacity	The model assumes that this calculation is carried out before rounding.
Schedule 17 Paragraph 19.7	Super-red adjustment	Import super-red	The model assumes that this calculation refers to the import capacity charge before bounding at zero, as otherwise it would never be negative.
Schedule 17 Paragraph 19.7	Part-year adjustment	Import super-red	The model assumes that the Average kW/kVA parameter referenced in this paragraph is the [Average kW/kVA] parameter without part-year adjustment.

DCUSA text reference	Assumption	Worksheet reference	Description
Schedule 17 Paragraph 19.8	Setting negative charges to zero	Import capacity, Import super-red	The model assumes that any negative import capacity charges or import super-red charges are set to zero before rounding.
Schedule 17 Paragraph 19.9	Transmission credits	Tariff inputs	The model assumes that "may include transmission credits" is wholly determined by the proportion eligible for credits, which is part of the input data.
Schedule 17 Paragraph 20.6	Exceeded export capacity charge	Exceeded export	The model assumes that no specific calculation is required for connectees with agreements with the DNO.
Schedule 17 Paragraph 20.9	Exceeded import capacity charge	Exceeded import	The model assumes that this uses the import capacity charge before it is rounded but after it is bounded at zero to remove negative values.
Schedule 17 Paragraph 25.2	LDNO discount calculation	LDNO calculations	The model assumes that LDNO discounts are to be calculated as per Section 7.4.1 of this document. That includes: <ul style="list-style-type: none"> • The mapping of discounts to CDCM tariff categories • The approach to discounting tariffs • The fact that generation tariffs can have discounts other than 0% or 100% (as they do in the CDCM)
Schedule 17 Paragraph 25.2	LDNO discounts for generators with no reactive power charge	LDNO calculations	The model assumes that LDNO discounts do not need to be calculated for the variants of the CDCM generation tariffs which do not have a reactive power charge
Schedule 17 Paragraph 26.11	LDNO scaling by 50%	Import capacity	The model assumes that this refers to residual revenue as calculated in Schedule 17 Paragraph 18.18 and Schedule 17 Paragraph 18.20.

DCUSA text reference	Assumption	Worksheet reference	Description
Schedule 17 Paragraphs 13.2, 16.6 and 24.1	COVID-19 Bad Debt Adjustment	Import capacity.	These paragraphs describe the treatment of bad debt within the FCP EDCM. DCP 379 introduced a new type of bad debt: COVID-19 bad debt. This was added explicitly into Schedule 15. The intention of DCP 379 was for this new pass-through cost to be applied to charges in the same way as other Eligible Bad Debt. We therefore assume that, where calculations refer to “Pass-through Eligible Bad Debt Adjustment”, the exact same calculations should be repeated for “Pass-through COVID-19 Bad Debt Adjustment”.